

# nexus 21

CONCEALMENT SYSTEMS

**TV Lift System Model L-27i  
Installation Instructions**



Below is a parts list describing all of the items included with the Model L-27i Lift System. You may also wish to refer to the dimensional diagram shown on Supplemental Page A for minimum installation dimensions (found on page 21).

**IMPORTANT DETAILS ABOUT THIS LIFT MODEL:**

This Lift Model is for use in an **inverted** orientation (e.g. lowering a TV from an upper kitchen cabinet) and cannot be used as a “pop-up” TV Lift. If your project calls for a pop-up lift (to raise your TV up from below), please call Nexus 21 customer Service, at (866) 500-5438.

Before beginning assembly and installation, please make sure that you have all items included on the list. If any parts are missing or damaged, please contact Nexus 21. Our contact information is shown at the top of this page.

**Parts List**



**1. Lift Column**  
(22" x 4")



**2. Base Mount**  
(2 3/4" x 6")



**3. Bayonet Bracket**  
(8" x 5 1/4")



**4. Screen Support**  
(6 1/2" x 18")



**5. Lid Plate**  
(18" x 4 1/2" - 6 1/2")



**6. Screen Back Plate**  
(24" x 9")



**7. Vertical Mounting Bars**  
(1" x 16 3/4")



**8. Control Box**  
(10 1/2" x 3 3/4" x 1 1/2")



**9. Lid Support Brackets**  
(14" x 2 3/4")

**NOTE:** Items 6 & 7 are packaged together in the “Nexus 21 Standard TV Mount” package.

## Cables

- **Motor Cable** – Black cable with white, six-pin plugs. Use this cable to connect the Lift Column to the Control Box (using port #1 on the Control Box). Six feet long.
- **Power Cable** – Connects Control Box to power outlet. Three feet long.
- **RF Cable** (only present if you ordered the RF version of the Lift System) – Use to connect the RF Receiver to the Control Box. Ends have telephone-style connectors. One foot long.



**TIP:** It is recommended to install a surge protector (not included) inside your cabinet to plug in the Lift System, Control Box, TV and any other components in the cabinet.

## Hardware

10. One (1) – Assorted Bag of TV Mounting Screws
11. Six (6) -- 6mm x 12mm Button Head Machine Screws
12. Two (2) -- Screen Locks (Located in box with Part #6 & 7)
13. Four (4) -- 3/8"-16 x 3/4" Button Head Machine Screws
14. Two (2) -- #10 x 1 3/4" Flat Head Wood Screws
15. Four (4) -- #8 x 3/4" Flat Head Wood Screws
16. Two (2) -- #4 x 1" Pan Head Wood Screws
17. Four (4) -- 6mm x 40mm Flat Head Machine Screws
18. Four (4) -- 6mm x 12mm Flat Head Machine Screws
19. Eight (8) -- #10 x 3/4" Truss Head Wood Screws
20. Four (4) -- 6mm x 16mm Button Head Machine Screws

## Contents of hardware pack that is labeled "Lid Stabilization Pack"

21. Two (2) -- 10-32 Nut
22. Two (2) -- 10-32 x 3" Threaded Studs
23. Two (2) -- Lid Stabilization Springs
24. Two (2) -- Brass Threaded Inserts
25. Two (2) – Flat Washers

## Other items that are included, but not shown in Parts View diagram on "Supplemental Page A" (at the end of this document):

- RF Controls or IR Controls (see explanation on page 6)
- Two (2) -- Allen Wrench – 4mm and 7/32"
- One (1) -- "Snakeskin" Wire Management Sleeve – 3 feet long
- Two (4) -- Velcro end Ties, for use with Wire Management Snakeskin
- Two (4) -- Plastic Ties, also for use with Wire Management Snakeskin
- Four (4) -- Wire Clips
- One (1) -- Small Cable Re-coiler
- Four (4) -- Square Multi-Mount Washers



## Wire Management



The Lift System has no exposed gears or moving parts that can damage your wires, so wire management is simple. We have included a three-foot long "SNAKESKIN" sleeve, which is a state-of-the-art wire bundling and protection system (the sleeve can be cut shorter if you wish). The System also includes 4 Velcro end ties, 4 plastic ties and a small cable re-coiler. Use the Velcro ties at the ends of the SNAKESKIN, to close the ends of the sleeve and to keep the wires together inside it. Use the plastic ties to fasten the cable bundle in a fixed position, so it moves up and down with the lift. Use the small cable re-coiler to assist pulling the cables back into your enclosure.

 **SAFETY INFORMATION** 

**SEVERE PERSONAL INJURY AND PROPERTY DAMAGE CAN RESULT FROM IMPROPER INSTALLATION OR ASSEMBLY. READ THE FOLLOWING WARNINGS BEFORE BEGINNING:**

<p style="text-align: center;"><b>TV HAZARD</b></p> 	<p style="text-align: center;"><b>ENCLOSURE LID HAZARD</b></p> 
<p><b>CAUTION:</b> Avoid contact with the TV and Lift System during operation. Use with caution.</p>	<p><b>CAUTION:</b> The enclosure lid must be installed as described in the instructions, using the Lid Stabilization hardware. Installing the lid in any other fashion will create hazardous pinch points that can cause serious personal injury.</p>

**WARNINGS:**

1. Do not use this product for any application other than those specified by Nexus 21.
2. Do not exceed the weight capacity. This can result in serious personal injury or damage to the equipment. It is the installer's responsibility to ensure that the total combined weight of all attached components does not exceed that of the maximum figure stated.
3. Follow all technical specifications and instructions during the installation.
4. Only use attachments/accessories specified by the manufacturer.
5. Close supervision is necessary when this system is being used by, or near, children, or disabled persons.
6. It is the responsibility of the installer to warn all potential users of the dangers of interfering with the mechanism during operation.
7. Read all technical instructions fully before installation and use. It is the installer's responsibility to ensure that all documentation is passed on the users and read fully before operation.
8. Failure to provide adequate structural strengthening, prior to installation can result in serious personal injury or damage to the equipment. It is the installer's responsibility to ensure the structure to which the Lift System is affixed can support four times the weight of the system.
9. Risk of electric shock. Do not attempt to open the Control Box.
10. To reduce risk of fire or electric shock, do not expose parts to rain or other liquids.
11. Protect the power cord from being walked on or pinched.
12. Keep all documentation.
13. Heed all warnings.
14. Clean only with a dry cloth.
15. Refer all service questions to Nexus 21 if the system does not operate normally.

*Nexus 21 disclaims any liability for modifications, improper installations, or installations over the specified weight range. Nexus 21 will not be liable for any damages arising out of the use of, or inability to use, Nexus 21 products. Nexus 21 bears no responsibility for incidental or consequential damages. This includes, but is not limited to, any labor charges for the servicing of Nexus 21 products performed by anyone other than Nexus 21.*

*Nexus 21 intends to make this and all documentation as accurate as possible. However, Nexus 21 makes no claim that the information contained herein covers all details, conditions or variations, nor does it provide for every possible contingency in connection with the installation or use of this product. The information contained in this document is subject to change without prior notice or obligation of any kind. Nexus 21 makes no representation of warranty, expressed or implied, regarding the information contained herein. Nexus 21 assumes no responsibility for accuracy, completeness or sufficiency of the information contained in this document.*

## Types of Controls for Nexus 21 Lift Systems

All Nexus 21 Lift Systems come standard with a **wireless remote control** and receiver. We offer a choice of two different type of remotes: IR and RF (both of which are explained in detail below). Our standard control type is RF, so unless you specifically requested the IR version when you made your purchase, you probably received the RF controls with this Lift System. The method of installation for each type of remote control is slightly different, so you should now identify which type of remote you have by reading below, and then follow the instructions for that type of remote.

**NOTE:** If you will be using the Lift with a home control system (like the ones made by companies such as Crestron or Control 4) the most common form of control is to WIRE IT DIRECTLY to the relays of your home control system. This direct-wire method is called **Integration by Contact Closure**, and is accomplished by using the Backup Control Switch (Height Limit Switch) that was supplied with the Lift System to connect the Lift to the control unit from your home control system.

### Before You Begin the Installation: Identify Your Control Type

**IR (Infrared)** – This control option allows you to utilize a 3<sup>rd</sup> party universal style remote control to raise and lower the TV Lift. Your universal remote will “learn” the IR codes from the provided IR Handset, which will enable you to control the lift. The universal remote will then communicate with the “eye” located on the IR Receiver via your 3<sup>rd</sup> party emitter (or flasher). Instructions for mounting the IR controls are on page 14. Instructions for setting the TV Lift’s travel limit are on Supplemental Page B.

**NOTE:** If you are NOT planning on using a 3<sup>rd</sup> party Universal Remote, switch to the RF setup. (There is no charge for swapping)

**These are the parts included with IR controls:**



**Contact Closure Hardware**



**IR Receiver**



**IR Handset**



**Height Limit Insert**

**RF (Radio Frequency)** - This system utilizes a wireless remote control handset that sends a radio signal to the RF Receiver. The radio signal can go through cabinet walls and does not require line-of-sight. Instructions for mounting the RF controls are on page 15. Instructions for setting the Lift System travel limit are on Supplemental Page B.

**TIP:** Planning to integrate the TV Lift with your UNIVERSAL REMOTE CONTROL? The RF version of the Nexus 21 controls won’t do it. Switch to IR.

**These are the parts included with RF controls:**



**Backup Switch**



**RF Receiver**



**RF Handset**



**Height Limit Insert**

**Integration by Contact Closure** – To direct-wire the TV Lift controls to a home control system (Crestron, Control 4, AMX, etc.) you will use the Back-up Control Switch (Height Limit Switch). You won’t use any Nexus 21 receiver or handset for this type of control because you will use the handset or control pad that comes with your home control system. **Instructions for setting up the System using Contact Closure are on “Supplemental Page C”.**

## About the Cabinet Lid Cover

**NOTE: The Lid Cover is not provided with the Lift System, as it is part of your cabinetry**

**What is the Lid Cover?** The Lid Cover is the piece of material that you choose to have “float” just below the TV. Typically, this material is made of wood and is not provided with the lift system. When the TV lift fully retracts, the Lid Cover will conceal the hole that is required for the system to drop-down through the cabinet and into view.



**IMPORTANT NOTE:** THE LID COVER IS OPTIONAL. Many people prefer to have the TV lower with no lid attached below the TV. If you are NOT going to be using a lid cover, please skip this section and continue to “Types of Controls” below.



**SAFETY NOTICE:**

- **WARNING! YOU MUST NOT DIRECTLY SCREW THE CABINET LID COVER TO THE LIFT SYSTEM!! THIS CREATES HAZARDOUS “PINCH POINTS” AND MAY AFFECT THE OPERATION OF THE LIFT OR CAUSE DAMAGE TO THE CABINET LID.**
- **DO NOT USE SCREWS to attach the lid cover to the Lift System.** Instead, use the “LID STABILIZATION PACK” (PARTS #22-25). This will keep the lid firmly in place, but will also allow it to **separate enough from the lift system** if anything (like a finger) gets in the way when the TV raises.

**How to do the Cut-Out Lid Cover** – You will “cut-out” part of your cabinet bottom, customizing it to the size of your TV. The dimensions for this cut-out are as follows: **Width= TV width plus 2”, Depth= TV Depth + 5.5”**. That cut-out lid then attaches to the lid plate of the Lift System and raises/lowers with the TV. This method uses the Lid Plate (part #7) and Lid Stabilization Pack (parts #22-25), but you must set up a “catch” for the cut-out lid so that when the TV raises, the lid stops level with the rest of your cabinet bottom (like a manhole cover). This procedure is described later on page 14.

## Assembly and Mounting – Things to Think About First



**SAFETY NOTICE:**

- For proper support, the Lift System MUST NOT be attached to any material that is less than  $\frac{3}{4}$ ” thick. This applies to BOTH the back and top mounting points.
- The Lift Column is ONLY designed and rated for VERTICAL, INVERTED USE. **DO NOT MOUNT THIS LIFT SYSTEM UPSIDE DOWN or SIDEWAYS (HORIZONTALLY, AS IN A LATERAL MOUNT)!**

**Space requirements for the L-23i Lift System are as follows:**

Depth= TV depth PLUS 5.5”

Height = TV height plus 1” or 23.2 minimum.

Width= the inside of the cabinet should be at least 2” wider than your TV.



**IMPORTANT NOTE:** The Lift System must be mounted **as low as possible inside the cabinet**, so that when the Lift is in the fully “UP” position (fully retracted), the bottom of the TV will be just above the lid of the cabinet.

**Lift System height and mounting position:**

When fully assembled, the HEIGHT of the Lift will be 23.2”.



**TIP:** If you need to mount the lift lower inside the cabinet, you can cut a wood block or mount a small shelf inside the cabinet for the top of the Lift Column (Base Mount) to mount on. Keep in mind that the “Bayonet Bracket” (part #3) will bear most of the weight.

## Assembly and Mounting Instructions – DETAILED STEPS

### Preparing the Enclosure Box

**BEFORE BEGINNING, PLEASE READ THE SAFETY NOTICE ON THE FIRST PAGE OF THIS DOCUMENT**

The Enclosure Box for the TV and Lift System should be constructed of materials no less than  $\frac{3}{4}$ " thick. We recommend a high-grade plywood or combi-core material. **The back and top of the enclosure are the parts that must be able to support the weight of the lift and TV, so particle board materials are not suitable for use in this project.**



The Enclosure Box dimensions depend on the size of your TV. Please review the Installation Dimensions Drawing on page 10 before beginning. **IF YOU HAVE THE SPACE, WE RECOMMEND INCREASING EACH DIMENSION BY 1" TO MAKE FOR EASIER INSTALLATION AND SERVICE ACCESS.**

The End, Front and Back panels of the Enclosure Box should be attached to the underside of the Top Cover, so that the Top Cover is resting on top of the four panels. This provides the maximum strength for holding the Lift and TV in its inverted orientation.

**Step 1: Cut the five panels from  $\frac{3}{4}$ " plywood.** Paint the inside of the panels a dark color before assembly. This will help camouflage the Enclosure Box after it is installed.

**Step 2: Determine where the electrical power will feed into the Enclosure Box. Cut out the appropriate sized opening near the top of the End Panel nearest the power feed.** We recommend using a 110V duplex outlet and conduit that conform to the building code for your location.

**Step 3: Cut out a Control Box Access door in one of the panels, to ensure accessibility of the control box.**

- a) This will provide convenient access to the electrical connections in the Control Box after installation.
- b) Put hinges and a latch (not provided) on the outside of the door so it opens **OUT**.
- c) Re-attach the Access Door to the Back Panel.

**Step 4: If a ventilation fan (not provided) is needed (in climates where attic temperatures exceed 110 degrees F), cut the opening for the fan near the top of the End Panel opposite the electrical feed. This will vent into the attic.**



## Assembly and Mounting Instructions – You Are Ready to Start

**Please perform the following steps, in order:**

**Step 1: Inventory the Parts List.** Carefully inspect all items, making sure you have everything shown in the Parts List.

**Step 2: Seat the “pigtail” cable properly on the top of the Lift Column.** Take the Lift Column (Part #1) and find the end with the short black cable (this cable is called the “pigtail”). This end will become the BOTTOM of the Lift Column. Before you begin to assemble the system, you must position the pigtail properly. Look at the bottom edge of the Lift Column. You will see two square cut-out channels, notched into the steel, one on either side of the pigtail. Choose one of the cut-outs (it does not matter which one), and seat the pigtail into the cut-out, using the rubber gasket attached to the cable.



**IMPORTANT NOTE:** IF THE PIGTAIL CABLE IS NOT PROPERLY SEATED, IT MAY BE DAMAGED WHEN YOU ATTACH THE SCREEN SUPPORT BRACKET (Part #4), CAUSING LOSS OF POWER TO THE LIFT COLUMN.



**IMPORTANT NOTE:** The pigtail now hangs over one side of the Lift Column. From this point forward, that side will be referred to as the “Front” of the Lift Column.

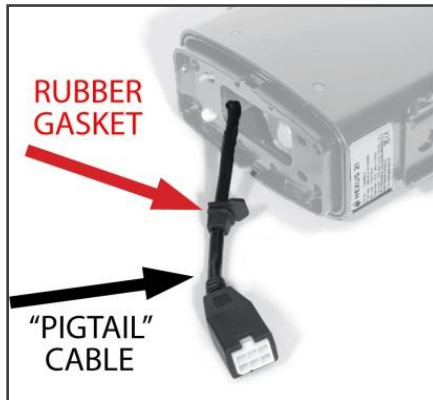

BEFORE (pigtail is loose)



AFTER (pigtail is properly seated)

**Step 3a: Attach the Bayonet Bracket to the Lift Column.** Slide the *Bayonet Bracket (Part #3)* onto the *Lift Column (Part #1)*. Stand the Lift Column up. Gently slide the *Bayonet Bracket* into the tapered, welded slots on either side of the *Lift Column* (on the opposite side of the pigtail cable).





**Step 3b:** Lightly tap the right and left side of the *Bayonet Bracket* with a rubber mallet to properly seat the bracket. Turn the *Lift Column* around and **check to make sure the *Bayonet Bracket* is level.**



**Step 4:** Place the *Base Mount (Part #2)* inside of your enclosure against the back wall and the top panel of the enclosure. Make sure to center the *Base Mount* from left to right inside the enclosure. Mark the four countersunk holes of the Base Mount. Using a  $\frac{1}{4}$ " drill bit, drill all four marked holes through the top panel of the enclosure.

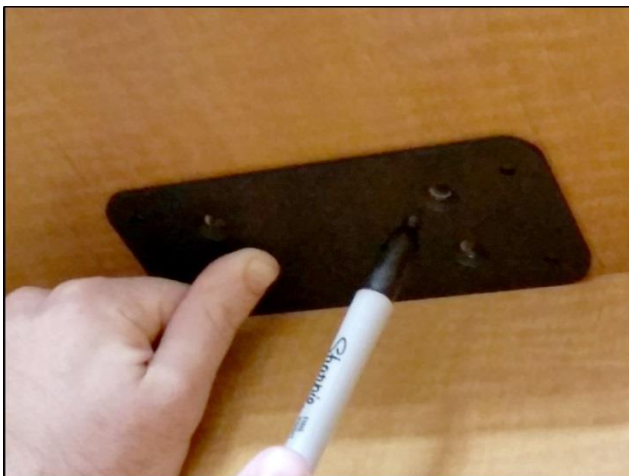

**Step 5:** Place the *Base Mount (Part #2)* on the top side of the top panel of the enclosure. Place (4) 6mm x 40mm FHMS through the Base Mount.





**Step 6: Attach the Lift Column to the Base Mount.** Place the *Lift Column (Part #1)* with the *Bayonet Bracket (Part #3)* attached against the back wall of the enclosure. Using the provided small *4mm Allen Wrench* drive the (4) *6mm x 40mm FHMS Screws* into the top of the lift column.

**NOTE:** The end of the Lift Column with the “pig-tail” is the bottom of the Lift Column.

**Step 7:** Using a level, make sure the *Lift Column* is level and parallel with side panels of the enclosure. Using (4) *#10 x 3/4” THWS Screws* mount the *Bayonet Bracket* to the back wall of the enclosure.



**Step 8:** Connect the *Motor Cable* to the pig-tail of the lift column.

**Step 9a: Attach the Screen Back Plate (Part #6) to the Screen Support Bracket (Part #4).** Using (4) 3/8-16 x 3/4" BHMS attached the Screen Back Plate to center of the Screen Support Bracket. **NOTE:** Make sure the bent tabs on the Screen Back Plate are on the top.



**Step 9b:** Place two Wire Clips to the inside wall of the Screen Support Bracket. Place one Wire Clip just below the upper set of PEM nuts. Place the second Wire Clip towards the top of the Screen Support Bracket.



**Step 10: Attach the Screen Support Bracket (Part #4) to the Lift Column (Part #1).** Using (4) 6mm x 16mm BHMS attached the Screen Support Bracket to the bottom of the Lift Column using the four outer most holes on the Screen Support Bracket. **NOTE:** Make sure to run the Motor Cable through the Wire Clips installed in the previous step to ensure proper cable management of the Motor Cable.





**Step 11: Attach the Top Support Brackets (Part #9) to the Screen Support Bracket (Part #4) . Using (6) 6mm x 12mm BHMS (3 screws per side) fasten the Top Support Brackets, so the bottom of the Top Support Brackets are a ½” above the opening at the bottom of the enclosure.**

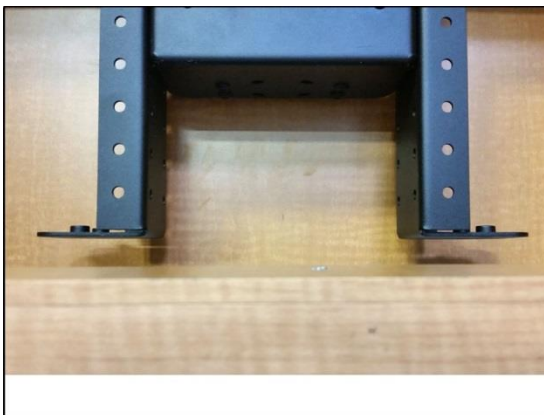
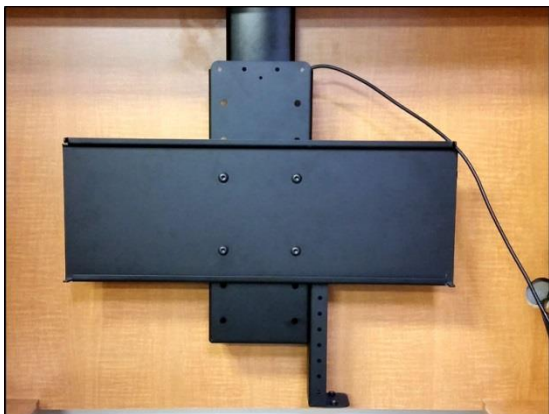

**Step 12: Attach the Lid Plate (Part #5) to the Top Support Brackets (Part #9). Using (4) 6mm x 12mm FHMS Screws attach the Lid Plate to the Top Support Brackets.**

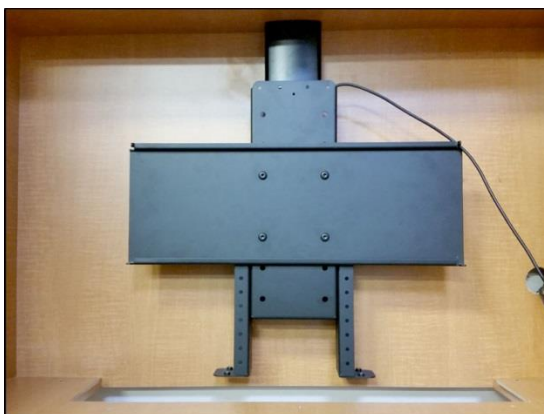

**Step 13: Mounting the Controls to the Back Panel of the Enclosure:** Using (2) #10" x 1 3/4" FHWS attach the *Control Box* and (2) #8" x 3/4" FHWS for the *IR or RF Receiver* (Depending on which Controls you ordered) to the back panel of the enclosure. The *RF Receiver or IR Receiver* will plug into either RJ45 port on the *Control Box*. The *Motor Cable* must plug in to Port # 1 on the *Control Box*.

Control Box



IR Receiver



Wired Back Up Switch



RF Receiver



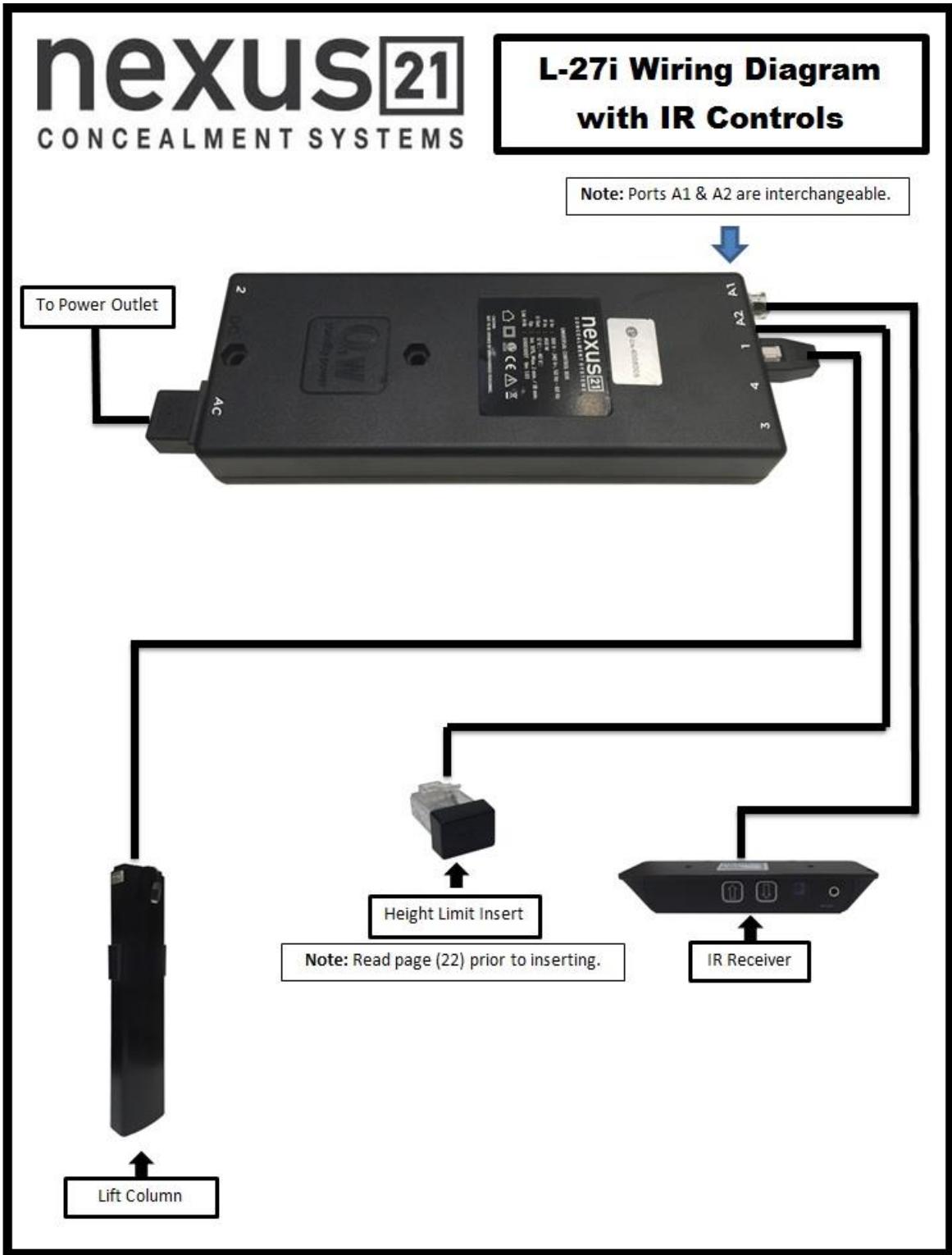

Once you have connected the controls, test the Lift Column as follows:

First, you need to "initialize" the Lift System. If you have already lowered the Lift Column, raise it again, since this step must be performed in the "up" or retracted position. Find the Wired Backup Switch, which has two triangle-shaped buttons - a DOWN (with raised dot) and an UP. Press the UP button and HOLD IT for approximately 5 seconds. You should see a slight movement in the Lift Column. If you do not see the movement, release the UP button, and repeat the process - press and hold the UP button again for 5 seconds. Once you have seen the slight movement, the Lift System is now functional. Test it by pressing the DOWN button (no need to hold the DOWN button) and the lift will lower. You may let it go all the way down, or stop it at any time by pressing the UP button.

IF YOU HAVE RF CONTROLS, USE THIS DIAGRAM (for IR Controls, see the previous page)

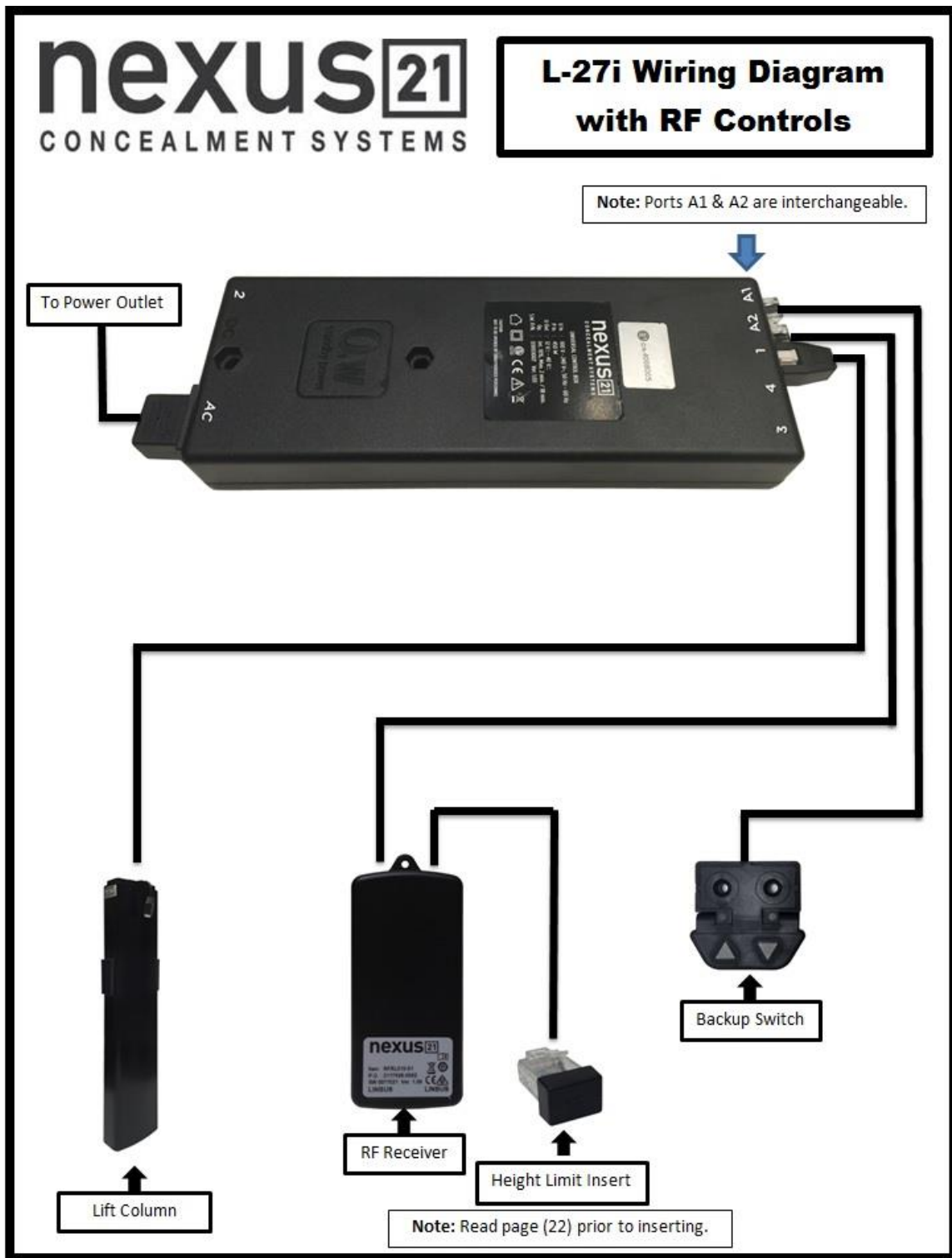

Once you have connected the controls, test the Lift Column as follows:

First, you need to “initialize” the Lift System. If you have already lowered the Lift Column, raise it again, since this step must be performed in the “up” or retracted position. Find the Wired Backup Switch, which has two triangle-shaped buttons - a DOWN (with raised dot) and an UP. Press the UP button and HOLD IT for approximately 5 seconds. You should see a slight movement in the Lift Column. If you do not see the movement, release the UP button, and repeat the process - press and hold the UP button again for 5 seconds. Once you have seen the slight movement, the Lift System is now functional. Test it by pressing the DOWN button (no need to hold the DOWN button) and the lift will lower. You may let it go all the way down, or stop it at any time by pressing the UP button.



## Installing the Lid Stabilization Assembly

The two Lid Stabilization Assemblies (each consisting of parts #21 - 25) are used to hold the Ceiling Cover Cut-out in proper alignment with ceiling opening. The assemblies are spring loaded so the Ceiling Cut-out will stop level with the ceiling allowing the Lift to travel an additional 1/8" – 1/2" up into the ceiling. You should create a "stop", or "lip" above the ceiling, around the edge of the opening, for your Ceiling Cover to pull up against, like an upside-down manhole cover. This illustration shows how it should work, and details for assembly are shown on the following pages.

### Side view of Lift System and Ceiling Cover, showing function of Lid Stabilization hardware

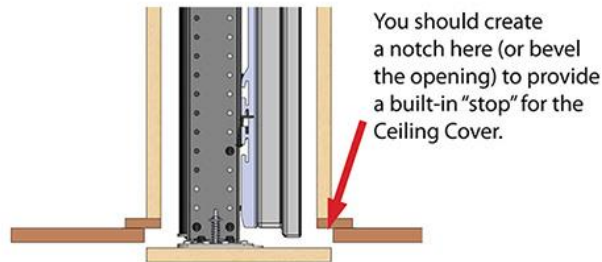

Side view of Lift System and Ceiling Cover, shown in the "almost closed" position.

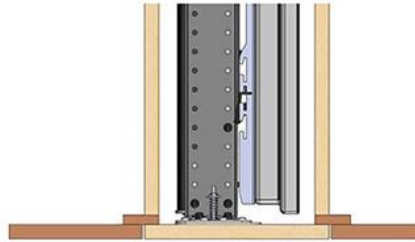

Ceiling Cover is now fully closed. Notice that the cover stops flush with the ceiling because of a notch that was created around the edge of the opening.

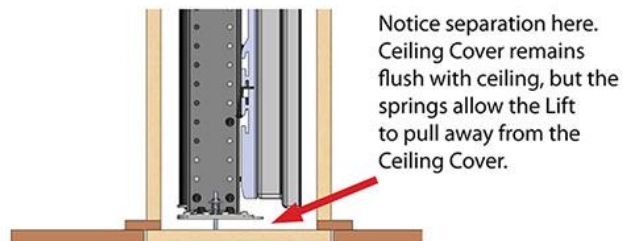

Once the Ceiling Cover is closed, the lift system is able to retract a little further into the Enclosure Box, thanks to the Lid Stabilization Springs.

**Step 14a:** Hold your lid piece (your ceiling cut-out piece) up to the *Lid Plate (part #5)*, which you have already installed on the lift. The *Lid Plate* has 2 holes that are used to attach your lid piece. Mark the position of the holes on your lid piece. Drill two holes  $\frac{1}{2}$ " deep using a  $\frac{3}{8}$ " drill bit in the marked positions.

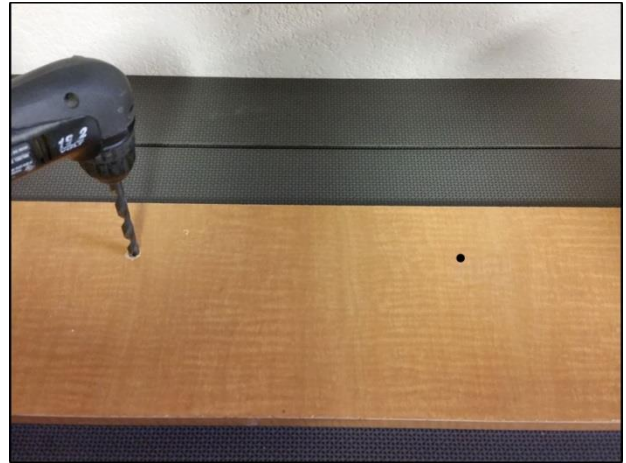

**Step 14b:** Using a flat head screw driver, drive the *Brass Inserts (Part #25)* into the  $\frac{1}{2}$ " deep holes. Make sure to drive the *Brass Inserts* into your lid material, so they are flush with the lid material.



**Step 15a:** Screw the (2) *Threaded Studs (Part#23)* into each *Brass Insert*, until they are fully seated.



**Step 15b:** Place the lid material against the bottom side of the *Lid Plate*; slide the *Threaded Studs* through the two holes on the *Lid Plate*. Slide (2) *Lid Stabilization Springs* (Part #24) over the *Threaded Studs*.



**Step 15c:** Add a 1" *Fender Washer* to the *Threaded Studs* on top of the spring you previously installed. Once washer is added, fasten a 10-32 *Nut* (Part #22) to the top of the *Threaded Studs*. You will need to compress the spring in order to screw the nuts down.

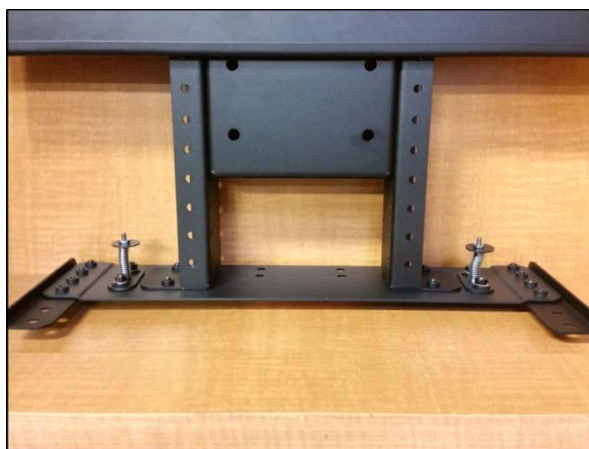



## Mounting the TV to the Lift

**A**

Flat/Unobstructed Back

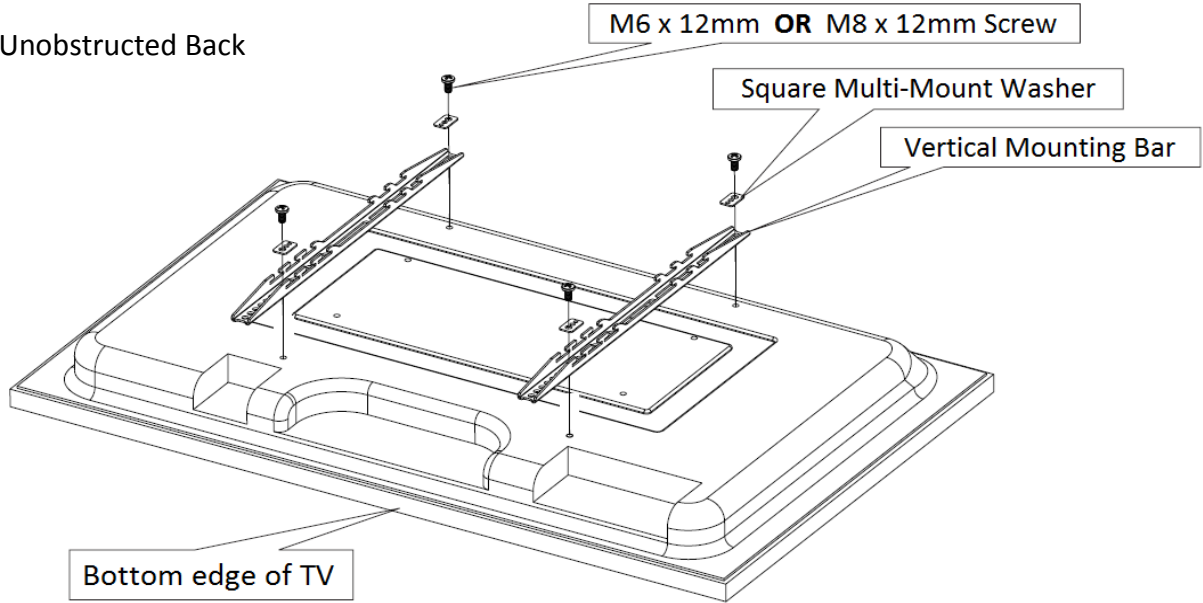

Diagram "A" installation procedure:

- 1) Place the flat screen TV face down on a protected surface.
- 2) Position the Vertical Mounting Bars equidistant from the bottom and top of the TV, with the slots facing toward the top of the TV.
- 3) Using the four (4) Square Multi-Mount washers and the TV mounting screws selected from the bag, attach and tighten the hardware. **DO NOT OVERTIGHTEN HARDWARE. DAMAGE TO TV MAY RESULT.**

**B**

Irregular/Obstructed Back

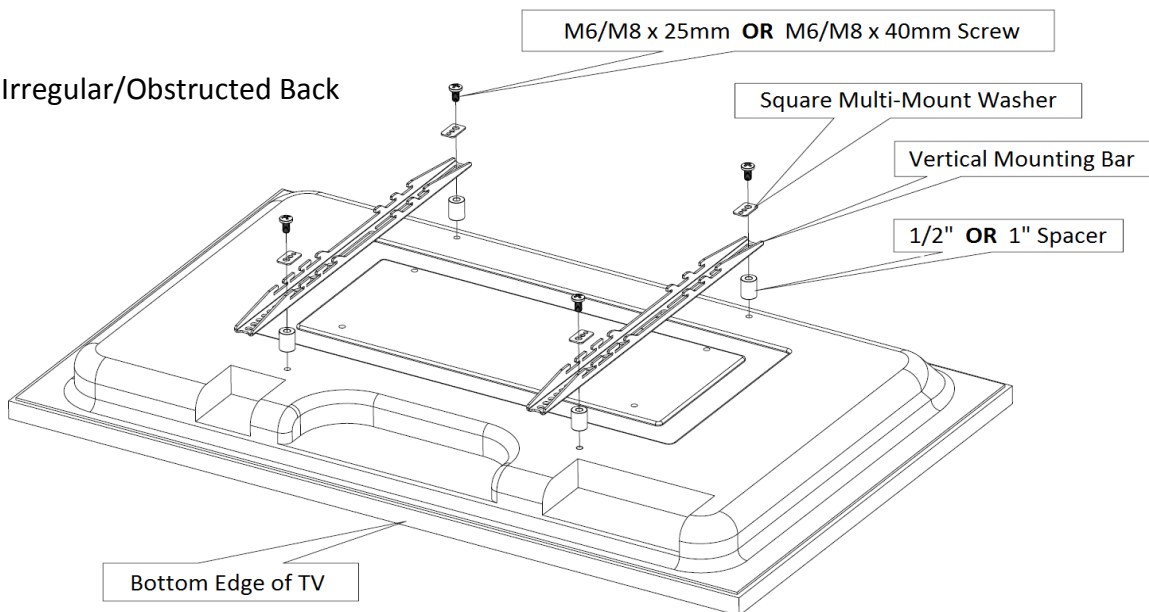

Diagram "B" installation procedure:

- 1) Place the flat screen TV face down on a protected surface.
- 2) Position the Vertical Mounting Bars equidistant from the bottom and top of the TV, with the slots facing toward the top of the TV.
- 3) Using the four (4) spacers needed, (4) Square Multi-Mount washers and the TV mounting screws selected from the bag, attach and tighten the hardware. The hardware will be used in this order (as shown in the diagram above): TV, Spacers, Vertical Mounting Bars, Square Multi-Mount Washers, TV Mounting Screws.

**DO NOT OVERTIGHTEN HARDWARE. DAMAGE TO TV MAY RESULT.**

**Step 16: Attach the Vertical Mounting Bars to the TV.** Before you begin, hand thread screws found in bag labeled “TV Mounting Screws/Spacers” into the threaded inserts on the back of your TV to determine the correct screw diameter (M6 or M8). The length of the screw required will depend on whether the TV has a flat/unobstructed or irregular/obstructed back. Follow diagram “A” for TV’s with flat/unobstructed back. Use diagram “B” for TV’s with irregular/obstructed back. The diagrams can be found on the following page.



**Step 17: Mount the TV (with the Vertical Mounting Bars attached) to the Screen Back Plate.** Each *Vertical Mounting Bar* has “hooks” on either end that allow the bars to “hang” on the *Screen Back Plate*. Lift the TV onto the *Screen Back Plate*. Center the TV. Be sure that both the upper and lower set of “hooks” fully engages with the *Screen Back Plate*.



**Step 18: Insert the Screen Locks into both Vertical Mounting Bars.** The *Screen Locks* will be placed into the lower “hook” that is just below the *Screen Back Plate*.

**Step 19: Tighten the Screen Locks.** Using a Phillips head screwdriver, tighten both *Screen Lock Screws* into the underside of the *Screen Back Plate*. This will lock your TV onto the TV Lift. You have now successfully attached your TV.

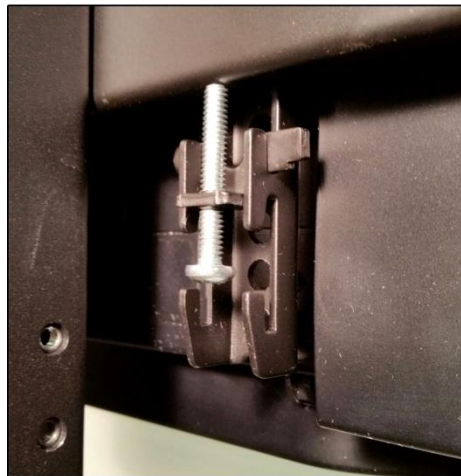

**Step 20: Attach the Cable Re-coiler to your cables.** Mount the provided Cable Re-coiler towards the top of your enclosure on the same side as the control box. Attach the cable to the bundle of wires that run to the back of your TV. This will help aid the cables back into the enclosure as the lift fully retracts. Test operate the lift and be sure that all wires are clear of the lift, so they do not get “hung up” when the TV is moving in either direction.

**Congratulations your L-27i Lift System is now completed!**

**Model L-27i  
Installation Dimensions:  
TV Drop Down System**

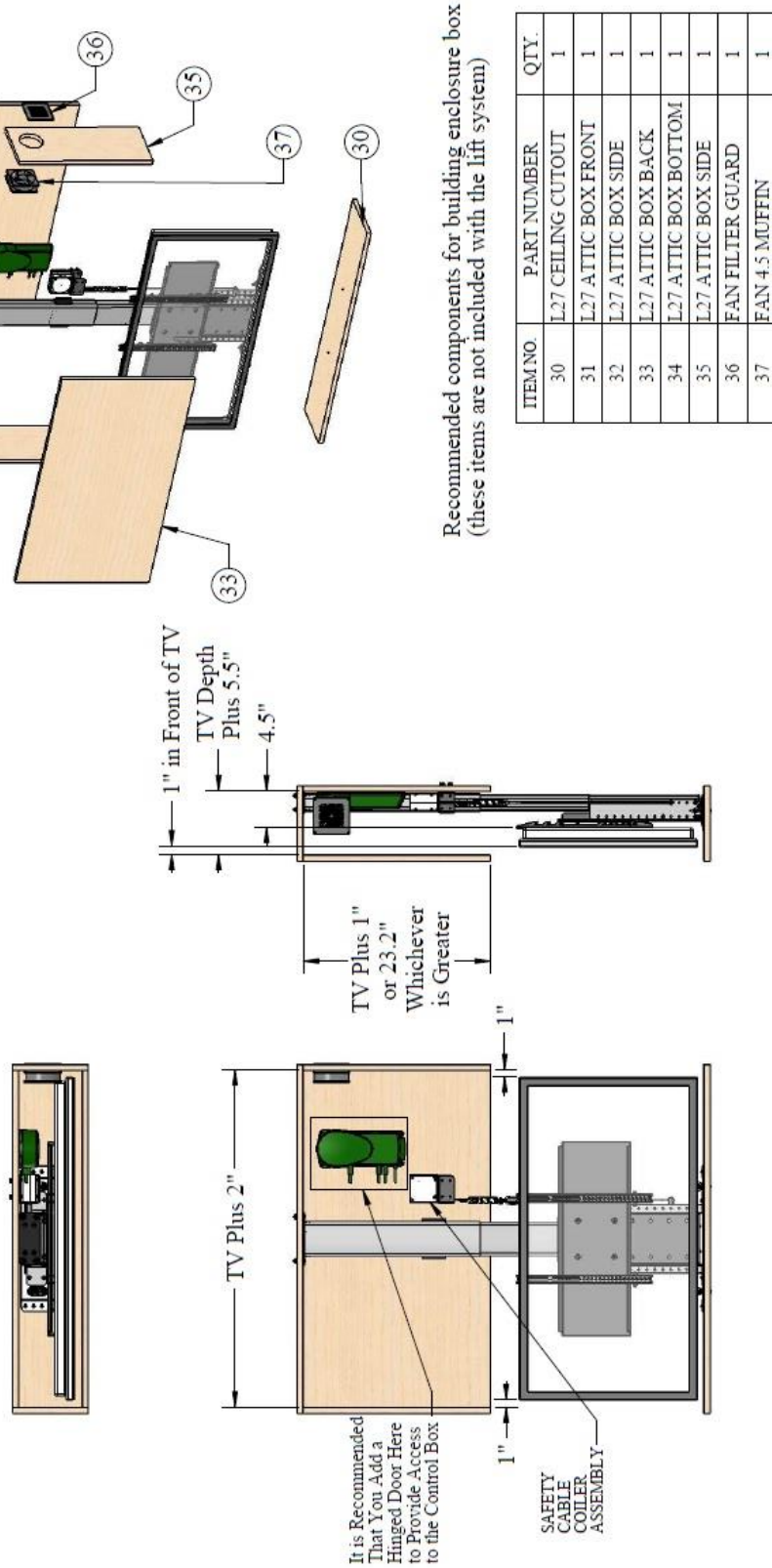

- Notes:**
- 1) This Installation Should only be Performed by a Licensed Contractor.
  - 2) TV Lift Mechanism with TV Weighs 180# Max (Not Including Surrounding Box Nor the Support Beams).
  - 3) System with Surrounding Enclosure Weighs Approx. 255#.
  - 4) Mechanism and TV Must be Enclosed to Remain Isolated to the Attic Environment.
  - 5) System Must be Tied into Trusses per Architectural Installation Drawing.
  - 6) Electrical Hookup to be per Authorized Building Codes.
  - 7) Maximum Extension of Lift is 26.5"



## Supplemental Page B: Setting a Height Limit

Please follow this procedure if you would like to limit the distance that your TV Lift extends.

### To set your Travel Limit with IR Controls:

If you want the lift system to always go to its full extension, do NOT use the Height Limit Insert. Simply leave it unplugged and the system will always travel to the full extension. To limit the travel, follow the procedure below:



1. Using the IR Receiver, run the lift system to height limit position and stop it there.
2. With the lift system stopped, plug the Height Limit Insert into the available RJ45 port on the Control Box. This will set the height limit at this position for both the IR Remote (or 3<sup>rd</sup> party universal remote) and the IR Receiver.
3. If the height limit is set at the incorrect position, remove the Height Limit insert and repeat the procedure.

### To set your Travel Limit with RF Controls:

If you want the lift system to always go to its full extension, do NOT use the Height Limit Insert. Simply leave it unplugged and the system will always travel to the full extension. To limit the travel, follow the procedure below:

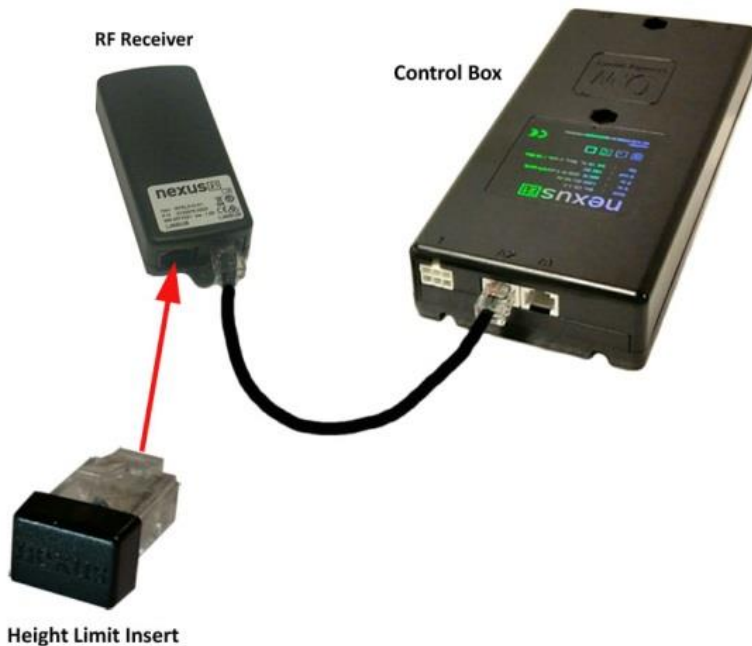

1. Using the Wired Backup Switch, run the lift system to the ideal height limit position and stop it there.
2. With the lift system stopped, plug the Height Limit Insert into the available RJ45 port on the RF Receiver. This will set the height limit at this position for both the RF Remote and Backup Switch.
3. If the height limit is set at the incorrect position, remove the Height Limit insert and repeat the procedure.



## Supplemental Page C: Connect the Lift to Home Control System

### Connecting the Nexus 21 Lift System to Other Control Systems

Use these instructions if you need to wire the Lift System directly to a Home Control System, like those made by Crestron, AMX, Control 4, RTI, etc. A common term for this method of integration is “connection by contact closure.”

#### Contents of Contact Closure Hardware Pack:

##### Step 1: Contact Closure Hardware Pack

This pack contains the following parts:

1 – *Contact Closure Cable*, RJ-45 to Relays

1 – *Height limit Insert*



Contact Closure Cable, RJ-45 to Relays



Height Limit Insert

##### Step 2: Connecting the Lift System to the Control System

Using the *Contact Closure Cable* to connect the three wires directly to the relays on your control module (see image below). Then connect the RJ-45 plug on the *Contact Closure Cable* to the Nexus 21 system, using either one of the two RJ-45 ports on the side of the Nexus 21 Control Box.

##### The colored wires function as follows:

**BLUE** = common (Pin 4 from RJ45) **GREEN** = Extend (Pin 5 from RJ45) **RED** = Retract (Pin 8 from RJ45)

##### Wire combinations for the relays:

The lift system uses two relays. One for “extend” and one for “retract.” The common wire runs between both relays, by using the **BLUE common wire**, together with a jumper wire you supply.

**Relay 1 Extend:** **BLUE** common wire with **GREEN** normally open.

**Relay 2 Retract:** **BLUE** common wire (use jumper) with **RED** normally open.



Close-up View of RJ-45 Pins



##### Step 3: Setting a Height Limit for the Lift System

Begin with the Height Limit Insert UNPLUGGED. Then send the “UP” command from your control system and run the Lift System up to your desired height. Once the Lift System is at the desired height, send the “DOWN” command to stop the lift at the point. Now PLUG the Height Limit Insert into the available RJ45 port on the Nexus 21 Control Box. The Lift will now remember the height and always stop at that point. To change, unplug the Height Limit Insert and repeat Step 3.

For technical support or to ask questions, call Nexus 21 Customer Service, toll-free at (866) 500-5438.

**nexus** **21**

**CONCEALMENT SYSTEMS**

866.500.5438