

# nexus 21

CONCEALMENT SYSTEMS

**TV Lift System Model L-27  
Installation Instructions**



Below is a parts list describing all of the items included with the Model L-27 Lift System. You may also wish to refer to the Parts View diagram shown on Supplemental Page A (at the end of this document).

Before beginning assembly and installation, please make sure that you have all items included on the list. If any parts are missing or damaged, please contact Nexus 21. Our contact information is shown at the top of this page.

## Parts List



**1. Lift Column**  
(22" x 4")



**2. Base Mount**  
(2 3/4" x 6")



**3. Bayonet Bracket**  
(8" x 5 1/4")



**4. Screen Support**  
(6 1/4" x 18")



**5. Top Plate**  
(18" x 4 1/2" - 6 1/2")

(This part may not be included when using a hinged-lid)



**6. Screen Back Plate**  
(24" x 9")



**7. Vertical Mounting Bars**  
(1" x 16 3/4")



**8. Control Box**  
(10 1/2" x 3 3/4" x 1 1/2")



**9. Top Support Brackets**  
(14" x 2 3/4")



**NOTE:** Items 6 & 7 are included in the "Nexus 21 Standard TV Mount" package.

## Parts List, continued

---

### Cables

- **Motor Cable** – Black cable with white, six-pin plugs. Use this cable to connect the Lift Column to the Control Box (using slot #1 on the Control Box). Six feet long.
- **Power Cable** – Connects Control Box to power outlet. Three feet long.
- **RF Cable (only present if you ordered the RF version of the Lift System)** – Use to connect the RF Receiver to the Control Box. Ends have telephone-style connectors. One foot long.



**TIP:** You may want to install a power strip (not included) in the bottom of your cabinet to plug in the Lift System Control Box, TV and any other components in the cabinet.

### Hardware

10. Two (2) -- 1 ½" x ¼" diameter Steel Threaded Taper Pins.
11. Six (6) -- 6mm x 12mm Button Head Machine Screws
12. Two (2) -- Screen Locks
13. Four (4) -- 3/8"-16 x ¾" Button Head Machine Screws
14. Two (2) -- #10 x 1 ¾" Flat Head Wood Screws.
15. Four (4) -- #8 x ¾" Flat Head Wood Screws
16. Four (4) -- 6mm x 20mm Flat Head Machine Screws.
17. Four (4) -- 6mm x 16mm Button Head Machine Screws
18. Four (4) -- 6mm x 12mm Flat Head Machine Screws
19. Eight (8) -- #10 x ¾" Truss Head Wood Screws

### Items that are included, but not shown in Parts View diagram on Supplemental Page A (at the end of this document):

- RF Controls or IR Controls (see explanation on page 5)
- One (1) -- Bag of Assorted TV Mounting Screws
- Two (2) -- Allen Wrench – 4mm and 7/32"
- One (1) -- "Snakeskin" Wire Management Sleeve – 3 feet long
- Four (4) -- Velcro end Ties, for use with Wire Management Snakeskin
- Four (4) -- Plastic Ties, also for use with Wire Management Snakeskin
- Four (4) -- Wire Clips
- Four (4) -- Square Multi-Mount Washers
- Four (4) -- Lid Catch Brackets w/ (8) #10 x ¾" THWS

## Wire Management

---



The Lift System has no exposed gears or moving parts that can damage your wires, so wire management is simple. We have included a three-foot long "SNAKESKIN" sleeve, which is a state-of-the-art wire bundling and protection system (the sleeve can be cut shorter if you wish). The System also includes 4 Velcro end ties and 4 plastic ties. Use the Velcro ties at the ends of the SNAKESKIN, to close the ends of the sleeve and to keep the wires together inside it. Use the plastic ties to fasten the cable bundle in a fixed position, so it moves up and down with the lift.

---

 **SAFETY INFORMATION** 

**SEVERE PERSONAL INJURY AND PROPERTY DAMAGE CAN RESULT FROM IMPROPER INSTALLATION OR ASSEMBLY. READ THE FOLLOWING WARNINGS BEFORE BEGINNING:**

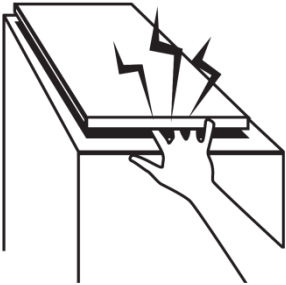
<p><b>TV HAZARD</b></p> 	<p><b>CABINET LID HAZARD</b></p> 
<p><b>CAUTION:</b> Avoid contact with the TV and Lift System during operation. Use with caution.</p>	<p><b>CAUTION:</b> The cabinet lid must be installed as described in the instructions, using the Steel Threaded Tapered Pins. Installing the cabinet lid in any other fashion will create hazardous pinch points that can cause serious personal injury.</p>

**WARNINGS:**

1. Do not use this product for any application other than those specified by Nexus 21.
2. Do not exceed the weight capacity. This can result in serious personal injury or damage to the equipment. It is the installer's responsibility to ensure that the total combined weight of all attached components does not exceed that of the maximum figure stated.
3. Follow all technical specifications and instructions during the installation.
4. Only use attachments/accessories specified by the manufacturer.
5. Close supervision is necessary when this system is being used by, or near, children, or disabled persons.
6. It is the responsibility of the installer to warn all potential users of the dangers of interfering with the mechanism during operation.
7. Read all technical instructions fully before installation and use. It is the installer's responsibility to ensure that all documentation is passed on the users and read fully before operation.
8. Failure to provide adequate structural strengthening, prior to installation can result in serious personal injury or damage to the equipment. It is the installer's responsibility to ensure the structure to which the Lift System is affixed can support four times the weight of the system.
9. Risk of electric shock. Do not attempt to open the Control Box.
10. To reduce risk of fire or electric shock, do not expose parts to rain or other liquids.
11. Protect the power cord from being walked on or pinched.
12. Keep all documentation.
13. Heed all warnings.
14. Clean only with a dry cloth.
15. Refer all service questions to Nexus 21 if the system does not operate normally.

*Nexus 21 disclaims any liability for modifications, improper installations, or installations over the specified weight range. Nexus 21 will not be liable for any damages arising out of the use of, or inability to use, Nexus 21 products. Nexus 21 bears no responsibility for incidental or consequential damages. This includes, but is not limited to, any labor charges for the servicing of Nexus 21 products performed by anyone other than Nexus 21.*

*Nexus 21 intends to make this and all documentation as accurate as possible. However, Nexus 21 makes no claim that the information contained herein covers all details, conditions or variations, nor does it provide for every possible contingency in connection with the installation or use of this product. The information contained in this document is subject to change without prior notice or obligation of any kind. Nexus 21 makes no representation of warranty, expressed or implied, regarding the information contained herein. Nexus 21 assumes no responsibility for accuracy, completeness or sufficiency of the information contained in this document.*

## Types of Controls for Nexus 21 Lift Systems

All Nexus 21 Lift Systems come standard with a **wireless remote control** and receiver. We offer a choice of two different type of remotes: IR and RF (both of which are explained in detail below). Our standard control type is RF, so unless you specifically requested the IR version when you made your purchase, you probably received the RF controls with this Lift System. The method of installation for each type of remote control is slightly different, so you should now identify which type of remote you have by reading below, and then follow the instructions for that type of remote.

**NOTE:** If you will be using the Lift with a home control system (like the ones made by companies such as Crestron or Control 4) the most common form of control is to WIRE IT DIRECTLY to the relays of your home control system. This direct-wire method is called **Integration by Contact Closure**, and is accomplished by using the Backup Control Switch (Height Limit Switch) that was supplied with the Lift System to connect the Lift to the control unit from your home control system.

### Before You Begin the Installation: Identify Your Control Type

**IR (Infrared)** – This control option allows you to utilize a 3<sup>rd</sup> party universal style remote control to raise and lower the TV Lift. Your universal remote will “learn” the IR codes from the provided IR Handset, which will enable you to control the lift. The universal remote will then communicate with the “eye” located on the IR Receiver via your 3<sup>rd</sup> party emitter (or flasher). Instructions for mounting the IR controls are on page 13. Instructions for setting the TV Lift’s travel limit are on Supplemental Page B.

**NOTE:** If you are NOT planning on using a 3<sup>rd</sup> party Universal Remote, switch to the RF setup. (There is no charge for swapping)

**These are the parts included with IR controls:**



Contact Closure Hardware



IR Receiver



IR Handset



Height Limit Insert

**RF (Radio Frequency)** - This system utilizes a wireless remote control handset that sends a radio signal to the RF Receiver. The radio signal can go through cabinet walls and does not require line-of-sight. Instructions for mounting the RF controls are on page 14. Instructions for setting the Lift System travel limit are on Supplemental Page B.

**TIP:** Planning to integrate the TV Lift with your UNIVERSAL REMOTE CONTROL? The RF version of the Nexus 21 controls won’t do it. Switch to IR.

**These are the parts included with RF controls:**



Backup Switch



RF Receiver



RF Handset



Height Limit Insert

**Integration by Contact Closure** – To direct-wire the TV Lift controls to a home control system (Crestron, Control 4, AMX, etc.) you will use the Back-up Control Switch (Height Limit Switch). You won’t use any Nexus 21 receiver or handset for this type of control because you will use the handset or control pad that comes with your home control system. **Instructions for setting up the System using Contact Closure are on “Supplemental Page C”.**

## Assembly and Mounting – Things to Think About First



### SAFETY NOTICE:

- For proper support, the Lift System MUST NOT be attached to any material that is less than 3/4" thick. This applies to BOTH the back and bottom mounting points.
- The Lift Column is ONLY designed and rated for VERTICAL, NON-INVERTED USE. **DO NOT MOUNT THIS LIFT SYSTEM UPSIDE DOWN or SIDEWAYS (HORIZONTALLY, AS IN A LATERAL MOUNT)!**



**TIP:** Inverted (drop down) lift systems are available from Nexus 21. Contact Customer Service at (866) 500-5438.

### Space requirements for the L-27 Lift System are as follows:

Depth = TV Depth + 5.5" (5.9" for hinged-top installations)

Height = TV Height + 1", or minimum 23.2" (23.5" with hinged-top), whichever is greater

Width = TV Width + 2"



**IMPORTANT NOTE:** The Lift System must be mounted as high up as possible inside the cabinet, so that when the Lift is in the fully "DOWN" position (fully retracted), the top of the TV will be just underneath the lid of the cabinet.

### Lift System height and mounting position:

The Top Support Brackets (Part #9) allow you to adjust the installation height of the Lift up to 8" (in 1/2" increments) to fit your cabinet height. When fully assembled, the HEIGHT of the Lift will be a minimum of 23.2" (configured for "floating top") or 23.5" (configured for "hinged top") and a maximum of 31.2" (floating top) or 31.5" (hinged-top) with the Top Support Brackets in the highest position. If the **inside height** of your cabinet is taller than this, you will need to mount the Lift **higher up inside the cabinet**.



**TIP:** If you need to mount the lift higher up inside the cabinet, you can cut a wood block or mount a small shelf inside the cabinet for the lift column to sit on. Keep in mind that the Bayonet Bracket (part #3) will bear most of the weight.

## About the Cabinet Lid (Cabinet Top)



### SAFETY NOTICE:

- **WARNING! YOU MUST NOT DIRECTLY SCREW THE CABINET LID (TOP) TO THE LIFT SYSTEM!! THIS CREATES HAZARDOUS "PINCH POINTS" AND MAY AFFECT THE OPERATION OF THE LIFT OR CAUSE DAMAGE TO THE CABINET TOP.**
- For floating lids, **DO NOT USE SCREWS to attach the lid to the Lift System**. Instead, use the "Threaded Taper Pins". This will keep the lid firmly in place, but will also allow it to **separate from the lift system** if anything (like a finger) gets in the way when the TV lowers.



### Which Lid Style Will You Use? (There are 3 Different Styles)

**Floating Lid (Floating Top)** – The whole top of the cabinet sits on top of the Lift System and raises/lowers with the TV. This is the standard installation method, using the Top Plate (part #5) and Threaded Taper Pins.

**Cut-Out Floating Lid (Top)** – You will "cut out" part of your cabinet top, customizing it to the size of your TV. That cut-out lid then sits on top of the Lift System and raises/lowers with the TV. This method uses the Top Plate (part #5) and Threaded Taper Pins, but you must set up a "catch" for the cut-out lid so that when the TV lowers, the lid stops level with the rest of your cabinet top (like a manhole cover).



**NOTE:** There are several different methods for setting up the "catch", but the hardware to do it is not included with the Lift System because it is part of the cabinet. Hardware suggestions include: buy 4 small corner brackets and screw to underside of main top, with edges exposed to catch the corners of the cut-out lid. The same thing can be accomplished with 1" x 1" "cleats", which are strips of hardwood, mounted underneath, with edges exposed to catch the lid.

**Hinged-Lid (Hinged-Top)** – The top is hinged at the back of the cabinet, behind the TV. It is pushed open by the motion of the Lift System when the lift travels up, and closes by gravity when the lift travels down. This type of installation does NOT use the Top Plate or the Tapered Guide Pins, but **requires use of the optional Nexus 21 "Hinged-Top Guides" (purchased separately)**.



**IMPORTANT NOTE:** For hinged-top installations, the pivot point of the hinge must be at least 2" behind the back of the Lift Column. This requires up to one inch of extra depth inside the cabinet. **TIP:** The actual HINGES are part of your cabinet and are not provided with the Lift.

## Assembly and Mounting Instructions – You Are Ready to Start

**Please perform the following steps, in order:**

**Step 1: Inventory the Parts List.** Carefully inspect all items, making sure you have everything shown in the Parts List.

**Step 2: Seat the “pigtail” cable properly on the top of the Lift Column.** Take the Lift Column (Part #1) and find the end with the short black cable (this cable is called the “pigtail”). This end will become the TOP of the Lift Column. Before you begin to assemble the system, you must position the pigtail properly. Look at the top edge of the Lift Column. You will see two square cut-out channels, notched into the steel, one on either side of the pigtail. Choose one of the cut-outs (it does not matter which one), and seat the pigtail into the cut-out, using the rubber gasket attached to the cable.



**IMPORTANT NOTE:** IF THE PIGTAIL CABLE IS NOT PROPERLY SEATED, IT MAY BE DAMAGED WHEN YOU ATTACH THE SCREEN SUPPORT BRACKET (Part #4), CAUSING LOSS OF POWER TO THE LIFT COLUMN.



**IMPORTANT NOTE:** The pigtail now hangs over one side of the Lift Column. From this point forward, that side will be referred to as the “Front” of the Lift Column.



**BEFORE (pigtail is loose)**



**AFTER (pigtail is properly seated)**



**Step 3: Attach the Base Mount to the bottom of the Lift Column.** Find the Base Mount (Part #2). Using the small Allen wrench and four of the 6mm x 20mm Flat Head Machine Screws (FHMS), attach the Base Mount to the bottom of the Lift Column (the end with NO pigtail). The Base Mount has 8 holes – use the 4 innermost holes, which will align with the 4 threaded holes in the bottom of the Lift Column. **DO NOT OVERTIGHTEN!**

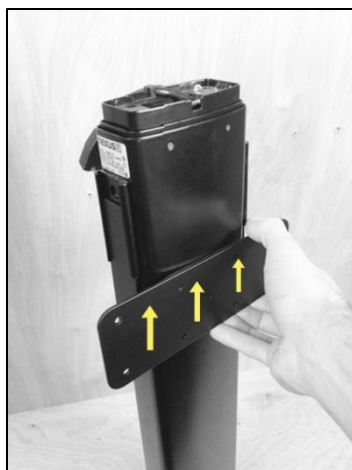

**Step 4: Slip the Bayonet Bracket into the receivers on the side of the Lift Column, on the opposite side of the pigtail cable.** Level the Bayonet Bracket.





**Step 5: Position the Lift Column (with Bayonet Bracket attached) in the cabinet.** Center the Lift within the enclosure.

**IMPORTANT NOTE:** *If the interior height of your cabinet exceeds 31.1" (the maximum height the lift can be) then you will need to create a mounting platform to raise the Lift System, so that the top of the Lift Column is within 8" of the underside of the cabinet lid. A small wood block can be used for this purpose.*

**Step 6: Attach the Bayonet Bracket to the back of the cabinet.** Using four (4) of the #10 x 3/4" Truss Head wood screws provided, attach the Bayonet Bracket to the back of the cabinet as indicated by the mounting holes. See **notes** below.



**NOTE:** *If your cabinet material is less than 3/4" you must use the supplied flat washers between the screw head and Bayonet Bracket – otherwise the 3/4" screw provided may be too long and will potentially penetrate through the other side of the wall.*



**NOTE:** *IF YOU ARE USING A HINGED-LID YOU MUST USE THE FOUR 3/8" SPACERS (provided with the Hinged-Top Guides) BETWEEN THE BAYONET BRACKET AND BACK WALL, ALONG WITH THE 1" FLAT HEAD WOOD SCREWS PROVIDED.*



**Step 7: Attach the Base Mount to the bottom of the cabinet using four (4) #10 x 3/4" Truss Head Wood Screws (THWS).** Make sure the Lift Column is level from side-to-side AND front-to-back.



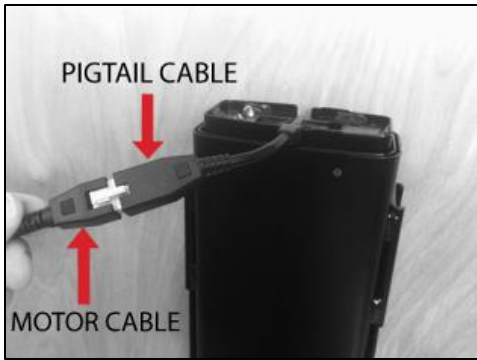

**Step 8: Plug the Motor Cable into the pigtail cable of the Lift Column.** The Motor Cable is the 6 foot cable with the 6-pin, white connectors on either end. The other end of this cable will remain loose for now.

## Assemble the Screen Support Sub-Assembly

The Screen Support Sub-Assembly consists of the following parts:

- #9 -- Top Support Brackets (2)
- #4 -- Screen Support Bracket
- #6 -- Screen Back Plate

If you know the vertical height measurement of your TV and the inside height of your cabinet, you can assemble this correctly the first time.



**Step 9: Fasten the Top Support Brackets to the Screen Support.** Make the following measurements before attaching the Top Support Brackets:

- Measure the inside height of your cabinet.
- Subtract 23.1" (23.4" for hinged-lid installations)

The resulting measurement is the height that the Top Support Brackets will extend above the Screen Support. If it doesn't line up exactly with the holes, use the **NEXT HIGHER SET OF HOLES** on the Top Support Brackets (making the assembly 1/2" lower).

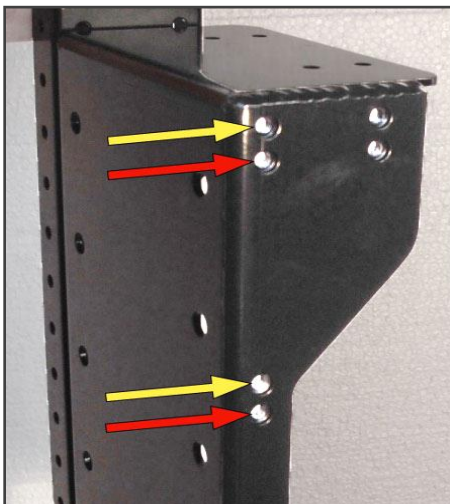

There are two sets of threaded holes on the side of the Screen Support, an upper set and lower set. Use the set that gets you closest to the measurement you need. Use six (6) of the 6mm x 12mm Button Head machine screws (three on each side) to attach the Top Support Brackets to the sides of the Screen Support.

**NOTE:** The photo at left shows a side-view of the Screen Support, with arrows pointing to the mounting holes for the Top Support Brackets. The yellow arrows point to the UPPER set of holes. The red arrows point to the LOWER set of holes



### Step 10: Attach the Screen Back Plate to the Screen Support Bracket.

You will want to install the Screen Back Plate so that it will be centered, or slightly higher than center, on the back of the TV after the TV is mounted. To calculate where to mount the Screen Back Plate on the Screen Support Bracket:

- Measure the height of your TV.
- Divide by 2.
- Measure that distance down from the top of the Top Support Brackets. This is the approximate center point where you will want to mount the Screen Back Plate to the Screen Support Bracket.
- Move the Screen Back Plate **UP** the Screen Support Bracket to the next set of available holes.



**Step 11:** Using the four (4) .38-16 x 3/4" Button Head machine screws attach the Screen Back Plate to the Screen Support Bracket by fastening the screws to the PEM Nuts on the Screen Support Bracket.

The Screen Support Sub-assembly should look like this when finished.



**Step 12:** Attach the Screen Support Sub-assembly to the top of the Lift Column. **BE SURE THE PIGTAIL ON THE TOP OF THE LIFT COLUMN IS PROPERLY SEATED (FACING FORWARD) IN THE SQUARE CHANNEL (SEE STEP #2) USING THE RUBBER GASKET ATTACHED TO THE CABLE.** Use four (4) 6mm x 16mm Button Head machine screws, to attach the Screen Support bracket to the top of the Lift Column. Tighten the machine screws, using the small Allen wrench provided.

**Step 13: Attach the Top Plate (part #5) to the Top Support Brackets.** The Top Plate is a 5-part plate (one Main Plate, two Extensions and two Fine-tuning Plates) that allows you to adjust the depth and position of the plate relative to the Threaded Tapered Pins (Steps 20-25). The Top Plate comes pre-assembled in a semi-retracted configuration. If you need to expand the depth of the plate to accommodate a deeper cabinet lid, remove the flat head machine screws from the Extensions, move them to the depth you need, and re-insert the machine screws. Fully retracted, the Top Plate has a depth of 4 ½", and can be adjusted to 5 ½" or 6 ½" with the Extensions on either end of the plate. (See Photo Below)

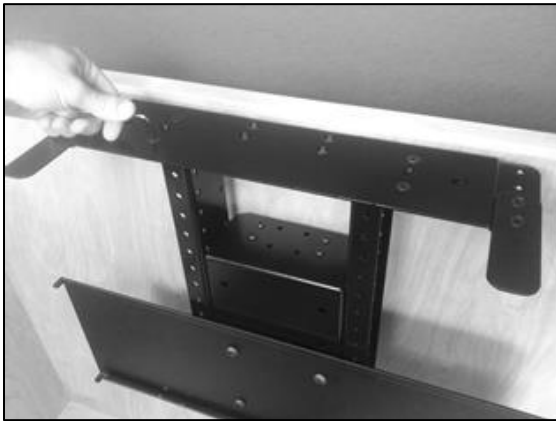

Insert four (4) of the 6mm x 12mm Flat Head machine screws into the countersunk holes on the Top Plate and attach them to the threaded holes in the Top Support Brackets. The Top Plate extends forward over the TV.

**Step 14: Attach the cables for IR Controls** as noted in the wiring diagram on the following, or on page 14 if you have **RF Controls**. Ensure that the motor cable is connected to port #1. The lift will not operate if motor the cable is connected to ports #2 or #3.

**IF YOU HAVE IR CONTROLS, USE THIS DIAGRAM** (for RF Controls, see the following page)

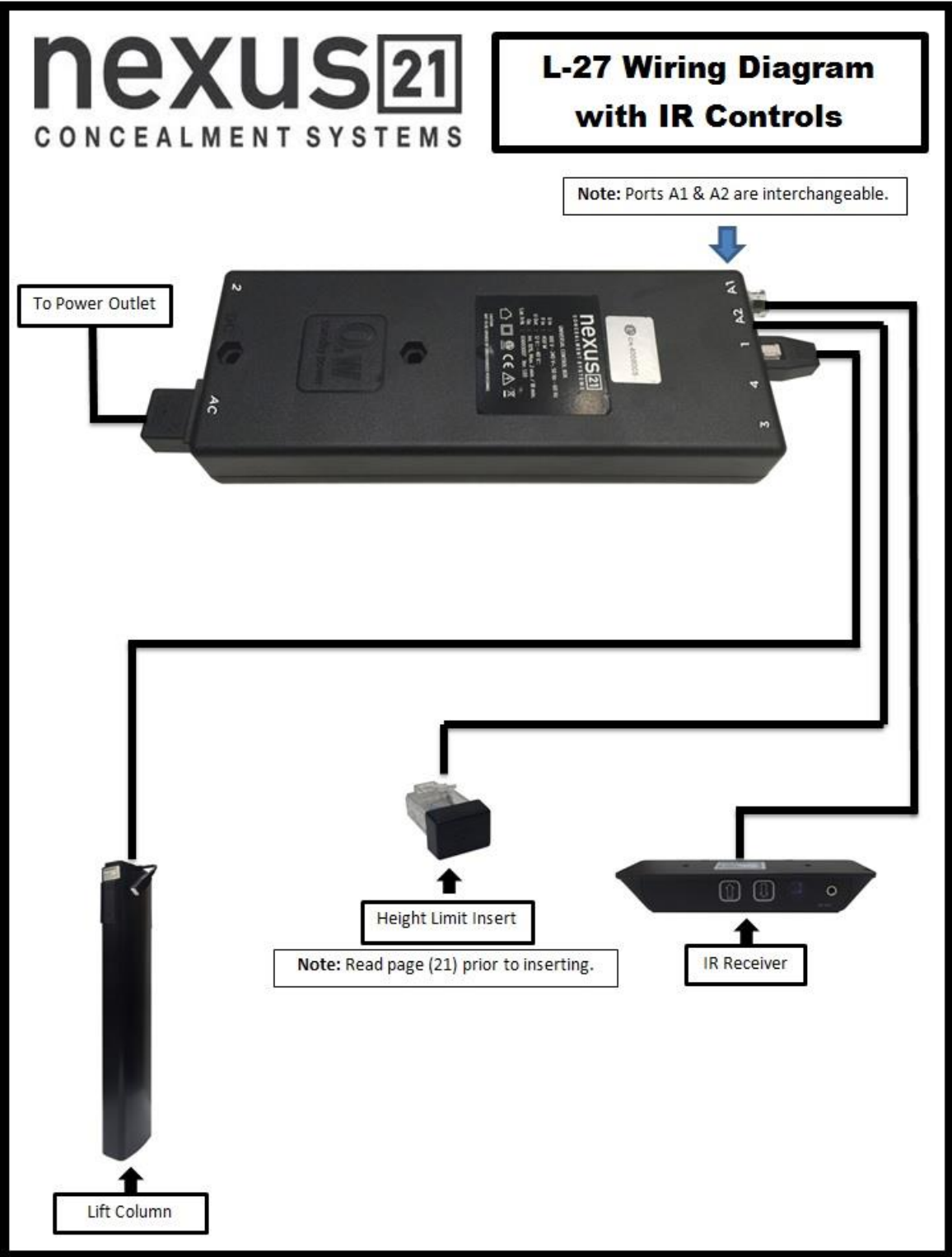

Once you have connected the controls, test the Lift Column as follows:

First, you need to “initialize” the Lift System. If you have already raised the Lift Column, lower it again, since this step must be performed in the “down” position. Find the Wired Backup Switch, which has two triangle-shaped buttons - an UP (with raised dot) and a DOWN. Press the DOWN button and HOLD IT DOWN for approximately 5 seconds. You should see a slight movement in the Lift Column. If you do not see the movement, release the Down button, and repeat the process - press and hold the Down button again for 5 seconds. Once you have seen the slight movement, the Lift System is now functional. Test it by pressing the Up button (no need to hold the Up button) and the lift will go up. You may let it go to the top, or stop it at any time by pressing the Down button.

**IF YOU HAVE RF CONTROLS, USE THIS DIAGRAM** (for IR Controls, see the previous page)

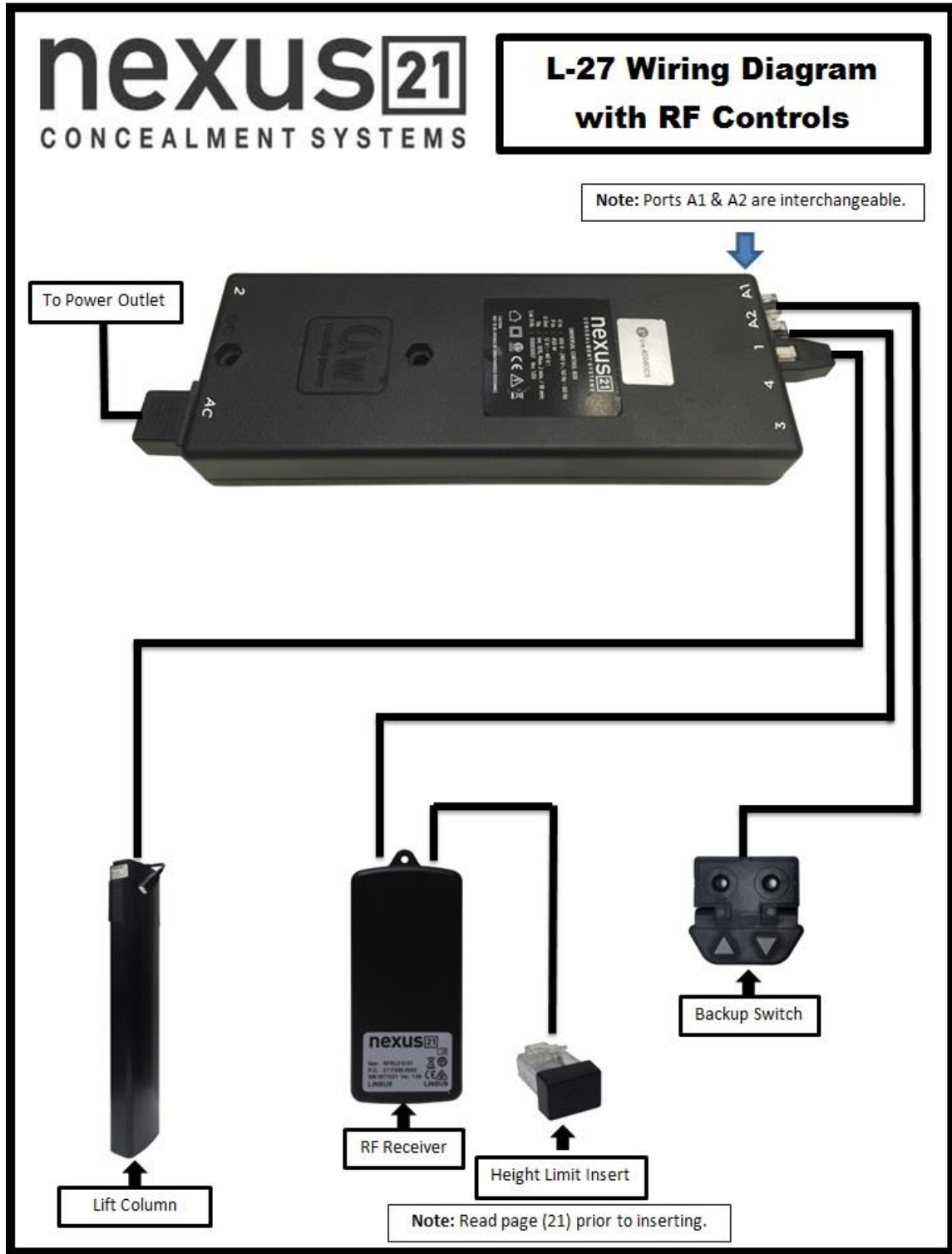

Once you have connected the controls, test the Lift Column as follows:

First, you need to “initialize” the Lift System. If you have already raised the Lift Column, lower it again, since this step must be performed in the “down” position. Find the Wired Backup Switch, which has two triangle-shaped buttons - an UP (with raised dot) and a DOWN. Press the DOWN button and HOLD IT DOWN for approximately 5 seconds. You should see a slight movement in the Lift Column. If you do not see the movement, release the Down button, and repeat the process - press and hold the Down button again for 5 seconds. Once you have seen the slight movement, the Lift System is now functional. Test it by pressing the Up button (no need to hold the Up button) and the lift will go up. You may let it go to the top, or stop it at any time by pressing the Down button.

## Mounting the Controls

If you have IR Controls, follow steps 15. For RF Controls, skip forward to step 16-18.

### INSTRUCTIONS FOR MOUNTING IR CONTROLS

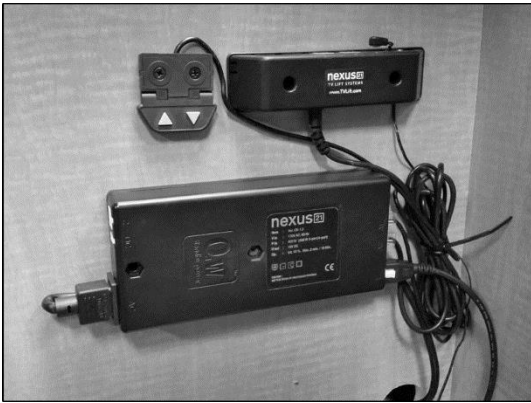

**Step 15: Attach the Control Box and IR Receiver to the inside of the cabinet.** Use four of the (2) #10 x 1 3/4" Flat Head Wood Screws to attach the Control Box to the inside of the cabinet. Use two of the #8 x 3/4" Flat Head Wood Screws to attach the IR Receiver to the inside of the cabinet.

**NOTE:** Mount the Control Box in an accessible place within the cabinet. Access to the Control Box is critical for troubleshooting if the Lift were to ever not function properly.

### INSTRUCTIONS FOR MOUNTING RF CONTROLS

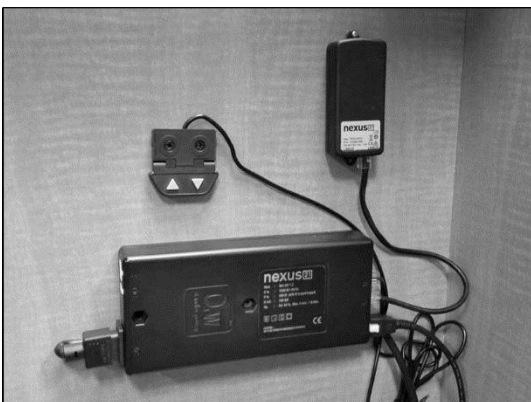

**Step 16: Attach the Control Box to the inside of the Cabinet.** Use two of the #10 x 1 3/4" Flat Head Wood Screws to attach the Control Box to the inside of the cabinet. **NOTE:** Mount the Control Box in an accessible place within the cabinet. Access to the Control Box is critical for troubleshooting if the Lift were to ever not function properly.

**Step 17: Attach the RF Receiver to the Cabinet.** Use two #6 x 3/4" Flat Head Wood Screws to attach the RF Receiver to the inside of the cabinet.

**Step 18: Attach the Height Limit Switch to the Cabinet.** You may mount this in any inconspicuous place, inside or outside the cabinet (you would need to drill a hole to mount it outside). Use two of the #8 x 3/4" Flat Head Wood Screws to mount the Switch.

## Last Thing to Do - Installing the Tapered Pins for the Floating Lid



In the previous section entitled “About the Cabinet Lid (Cabinet Top)”, we explain the difference between “Hinged Lids” and “Floating Lids”. If your cabinet has a Hinged Lid, you will not use the Tapered Pins at all, and you can skip to Step 26.



### SAFETY NOTICE:

**WARNING! YOU MUST NOT DIRECTLY SCREW THE CABINET LID (TOP) TO THE LIFT SYSTEM!! THIS CREATES HAZARDOUS “PINCH POINTS” AND MAY AFFECT THE OPERATION OF THE LIFT OR CAUSE DAMAGE TO THE CABINET TOP.** For floating lids, **DO NOT USE SCREWS to attach the lid to the Lift System.** Instead, use the “Threaded Tapered Pins”, as described below.

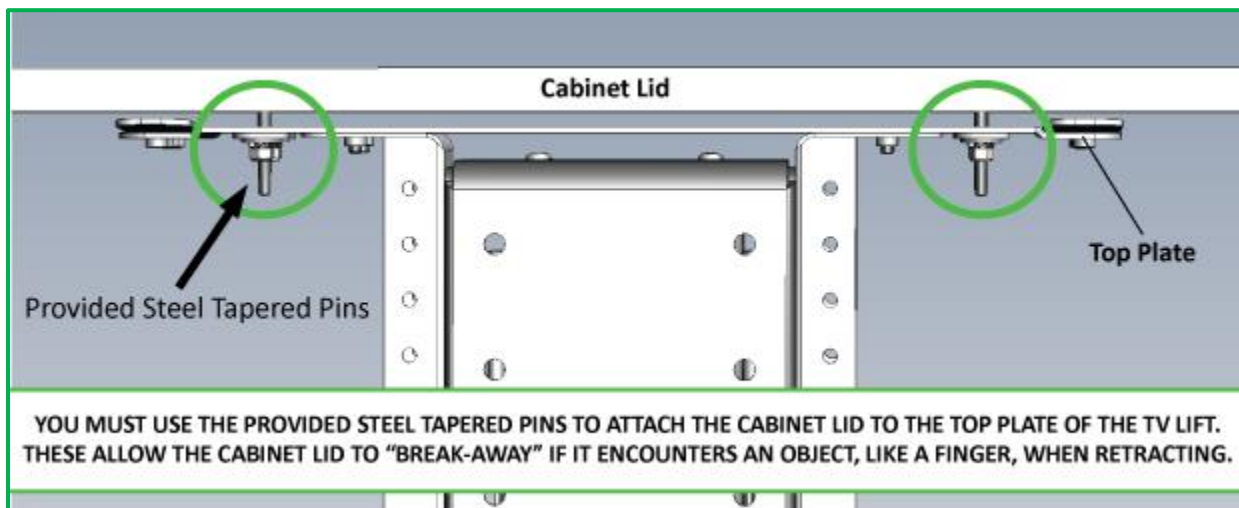

### What Are the Tapered Pins, and Why Use Them?

The two 1 ½” x ¼” Steel Threaded Taper Pins are used IN PLACE OF SCREWS to hold your cabinet top (lid) in place on the Lift System Top Plate (Part #5). The Taper Pins will keep your lid firmly in place, but will also allow it to **separate from the lift system** if anything (like a finger) gets in the way when the TV lowers. [See Safety Notice above. Please do NOT use screws with your cabinet lid.](#)

### Before You Install the Tapered Pins, Here is a Reminder of the Two Types of Floating Lids (Floating Tops):

**Cut-Out Floating Lid** – This option assumes that you have “cut out” part of your cabinet top, customizing it to the size of your TV. That cut-out lid then sits on the Top Plate of the Lift System, held in place by the Tapered Pins, and raises/lowers with the TV. You must set up a “catch” for the cut-out lid so that when the TV lowers, the Lid stops level with the rest of your cabinet top (like a manhole cover), and the Lift System continues down a little further into the cabinet (no more than ¼” to ½”). In this way, when the Lift System is fully retracted, the Cut-Out Lid will always be level, and the Top Plate of the Lift System will always be positioned just below the Lid. Since the Lid and the Top Plate are slightly separated from one another, but still very close, the Tapered Pins (which are 1 ½” long) will still be hanging down through the holes in the Top Plate so when the Lift System moves, everything is properly aligned and the Lid rides smoothly up and down. See illustration on following page.

**Floating Lid (Floating Top)** – The whole top of the cabinet sits on top of the Lift System and raises/lowers with the TV.



**NOTE:** There are several different methods for setting up the “catch” for your Cut-Out Lid, but the hardware to do it is not included with the Lift System because it is part of the cabinet. Hardware suggestions include: buy 4 small corner brackets and screw to underside of main top, with edges exposed to catch the corners of the cut-out lid. The same thing can be accomplished with 1” x 1” “cleats”, which are strips of hardwood, again mounted underneath, with edges exposed to catch the lid.

**How to Install the Tapered Pins:**

You will be screwing the Tapered Pins into the UNDERSIDE of your cabinet lid, and they will hang down and drop into the two holes in the Top Plate (Part #5).

**Step 19: Before installing the Tapered Pins, position the Cabinet Lid.** With the TV and the Lift System in the fully DOWN position, set the Cabinet Lid in place. It will not be attached at this point, so move it around on the Top Plate, making sure it is straight with the cabinet.

**Step 20: Run the Lift System up and down with the Cabinet Lid sitting on top, but not attached.** Without bumping the Cabinet Lid out of place, use the Remote Control Handset to send the Lift System up and down. Make sure that when the Lift comes down, the Cabinet Lid drops into the proper position relative to your cabinet.

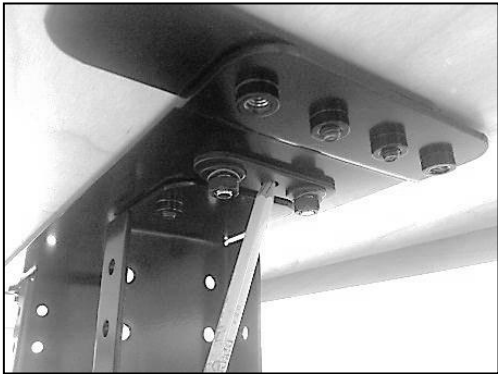

**Step 21: Mark the spots for the Tapered Pins.** Again, without bumping the Cabinet Lid out of place, run the Lift System all the way UP, with the Cabinet Lid sitting on top. Look at the UNDERSIDE of the Top Plate, find the two holes, and use a felt-tip pen or a pencil to mark the position of the holes on the underside surface of the Cabinet Lid.



**TIP:** You will have a ¼” tolerance (in all directions) for the placement of the Tapered Pins into your cabinet lid. There are a set of nuts on the underside of the Top Plate that allow you to adjust the position of the hole that the Tapered Pins will pass through to secure the cabinet lid to the Top Plate. If you happen to position the Tapered Pins a few millimeters off from your intended position, you can still make adjustments to fit properly.



**Step 22: Remove Cabinet Lid and drill two holes.** Use a 7/32” drill bit to drill two holes, ½” deep, in the underside of the Cabinet Lid.

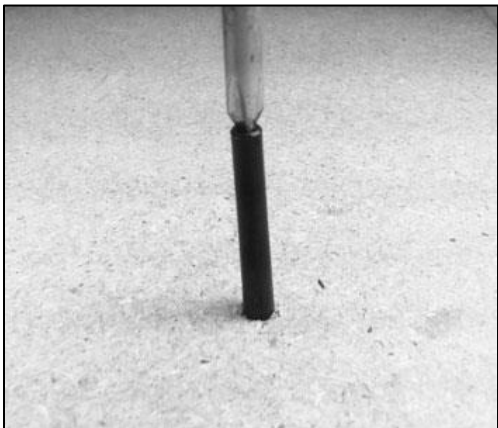

**Step 23: Use some glue.** Put a drop of glue (not provided) into each hole and immediately hand-tighten the Threaded Tapered Pins into the holes, or if necessary, use a Phillips screwdriver to drive the pins. Allow the glue to dry, according to the drying time specified in the glue instructions.



Tapered Pins



**Step 24: Place the Cabinet Lid onto the Lift System.** Align the Tapered Pins with the 2 holes in the Top Plate and put the Lid on. Tighten the nuts on the underside of the hole where the Tapered Pins pass through the Top Plate to secure it.



Underside of Cabinet Lid, with Tapered Pins

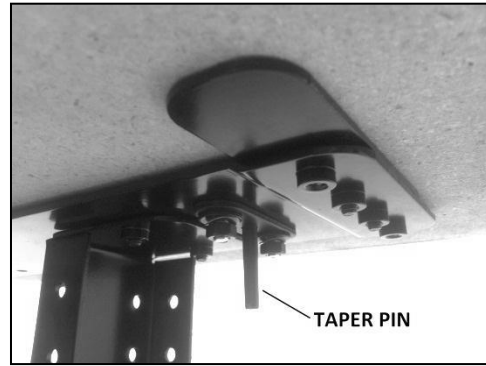

Tapered Pin passing through Top Plate

**Step 25: Do a wire management check.** Test operate the Lift and be sure that all wires are clear of the Lift so they do not get “hung up” when the TV Lift is moving up and down. Refer back to the previous step entitled “Using Wire Management”.

## Mounting the TV to the Lift

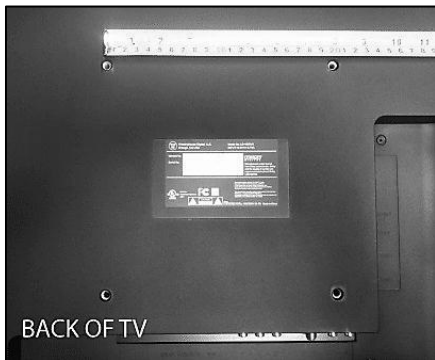

Width of Mounting Holes



Height of Mounting Holes

**Step 26: Measure the Space between the Mounting Holes on the back of the TV.** If the distance between the mounting holes exceeds 30” in width or 19 ½” in height, you will need to use Bracket Extenders. These can be obtained by calling Product Support at 866-500-5438.

**Step 27: Attach the Vertical Mounting Bars to the TV.** Before you begin, hand thread screws (found in bag labeled “TV Mounting Screws/Spacers”) into the threaded inserts on the back of your TV to determine the correct screw diameter (M6 or M8). The length of the screw required will depend on whether the TV has a flat/unobstructed or irregular/obstructed back. Follow diagram “A” for TV’s with flat/unobstructed back. Use diagram “B” for TV’s with irregular/obstructed back. The diagrams can be found on the following page.

**A****Flat/Unobstructed Back**

Diagram "A" installation procedure:

- 1) Place the flat screen TV face down on a protected surface.
- 2) Position the Vertical Mounting Bars equidistant from the bottom and top of the TV, with the slots facing toward the top of the TV.
- 3) Using the four (4) Square Multi-Mount washers and the TV mounting screws selected from the bag, attach and tighten the hardware. **DO NOT OVERTIGHTEN HARDWARE. DAMAGE TO TV MAY RESULT.**

**B****Irregular/Obstructed Back**

Diagram "B" installation procedure:

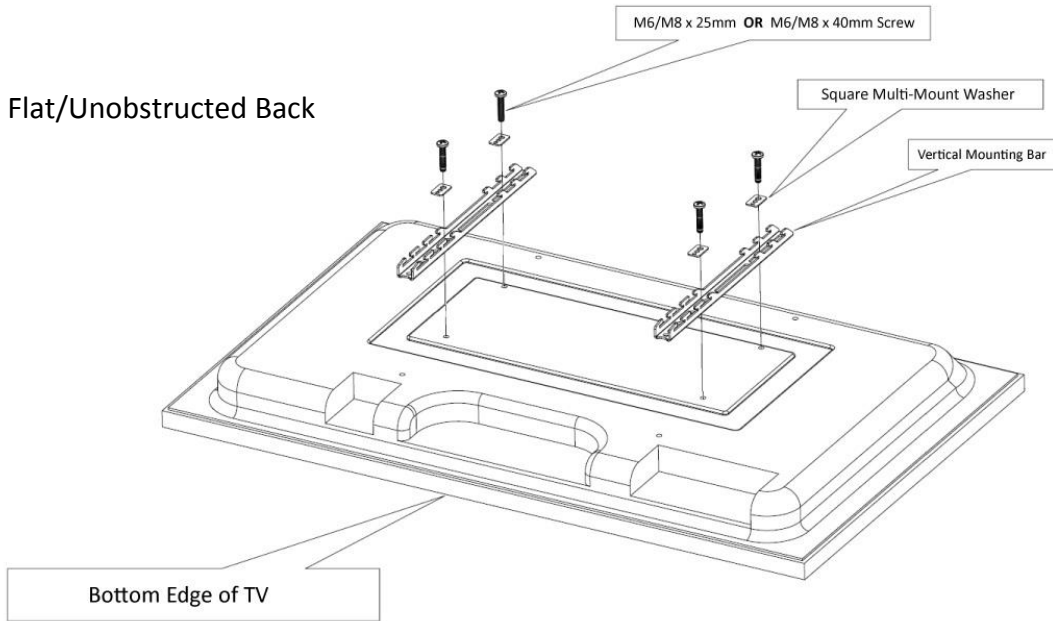
- 1) Place the flat screen TV face down on a protected surface.
- 2) Position the Vertical Mounting Bars equidistant from the bottom and top of the TV, with the slots facing toward the top of the TV.
- 3) Using the four (4) spacers needed, (4) Square Multi-Mount washers and the TV mounting screws selected from the bag, attach and tighten the hardware. The hardware will be used in this order (as shown in the diagram above): TV, Spacers, Vertical Mounting Bars, Square Multi-Mount Washers, TV Mounting Screws.

**DO NOT OVERTIGHTEN HARDWARE. DAMAGE TO TV MAY RESULT.**

**Step 28: Mount the TV (with the Vertical Mounting Bars attached) to the Screen Back Plate.** Each Vertical Mounting Bar has “hooks” on either end that allow the bars to “hang” on the Screen Back Plate. Lift the TV onto the Screen Back Plate. Center the TV. Be sure that both the upper and lower set of “hooks” engages the Screen Back Plate.

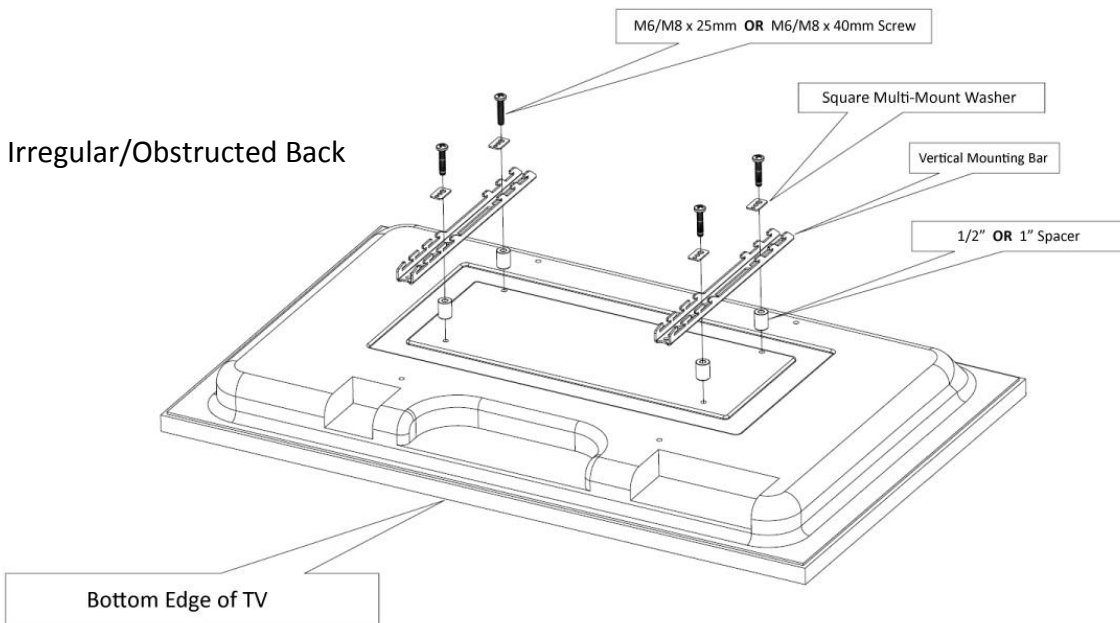
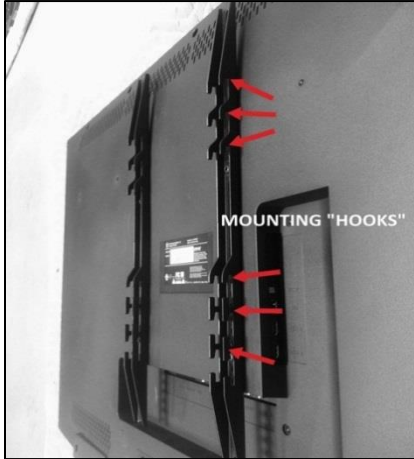

*Vertical Mounting Bars attached to back of TV*



*TV Lift removed to show “hooks” engaged with Screen Back Plate*

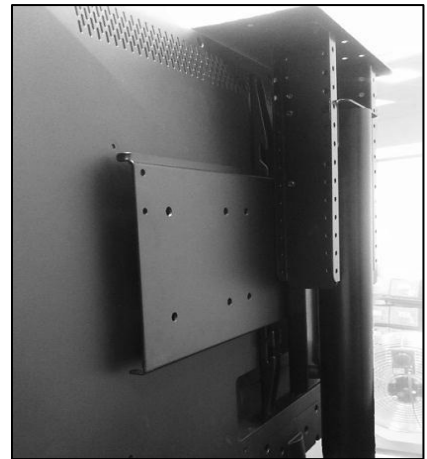

*Shown fully mounted on TV Lift*

**Step 29: Insert the Screen Locks into both Vertical Mounting Bars.** The Screen Locks will be placed into the lower “hook” that is just below the Screen Back Plate.

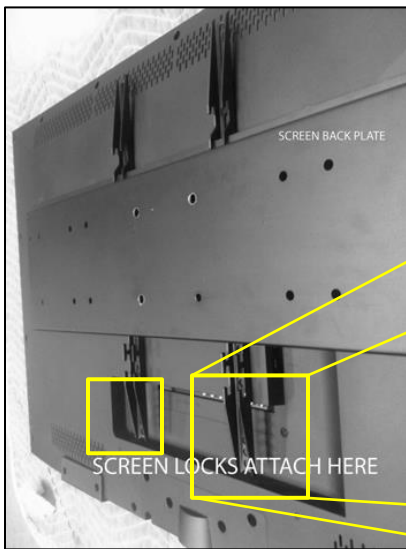

*TV Lift removed for photo*

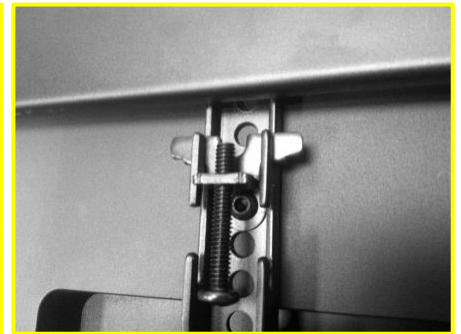
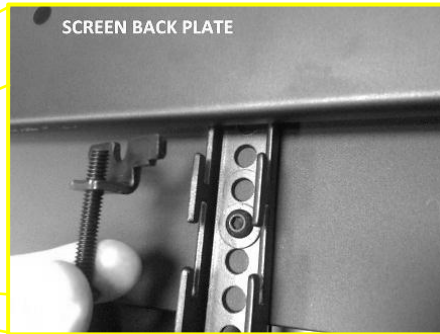

**Step 30: Using a Phillips head screwdriver, tighten both Screen Lock screws into the underside of the Screen Back Plate.** This will lock your TV onto the TV Lift. You have now successfully attached your TV.



**Step 31: Do a final wire management check.** Test operate the Lift and be sure that all wires are clear of the Lift so they do not get “hung up” when the TV is moving either up or down. Refer back to the previous step entitled “Using Wire Management”.

**You have successfully installed your Model L-27 TV Lift.**

## Supplemental Page A: Parts View Diagram

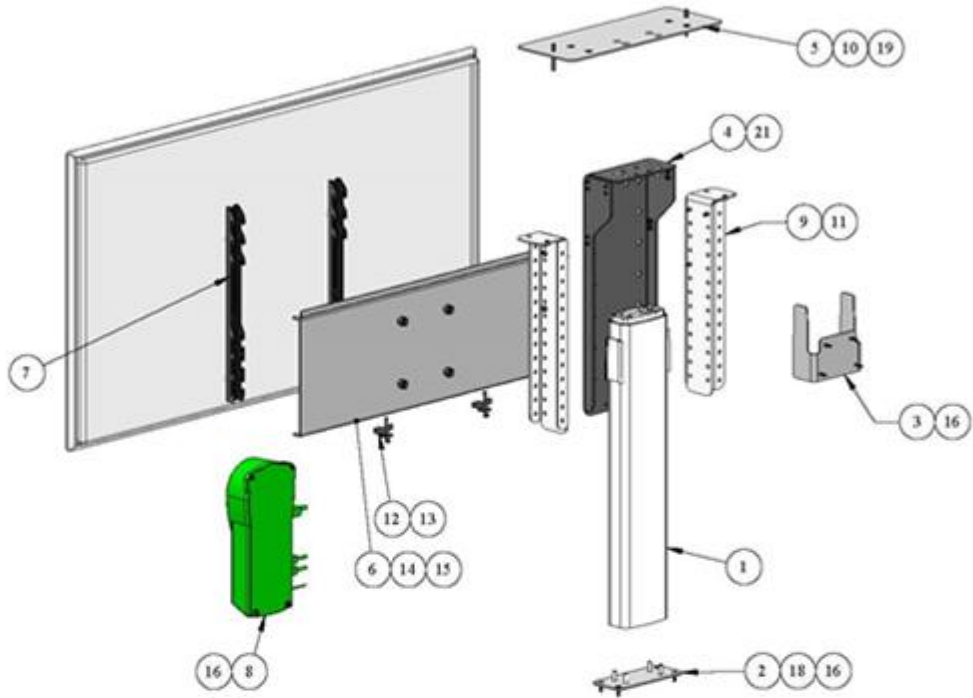

ITEM NO.	PART NUMBER	QTY.
1	L-27 LIFT COLUMN	1
2	BASE MOUNT	1
3	BAYONET BRACKET	1
4	SCREEN SUPPORT	1
5	UNIVERSAL TOP PLATE	1
6	24 IN SCREEN BACK PLATE	1
7	15.75 IN VERTICAL MOUNT LEG	2
8	CONTROL BOX	1
9	TOP SUPPORT BRACKET	2
10	1.5 X .25 DIA STEEL THREADED TAPER PIN	2
11	6MM X 12 BUTTON HEAD MACHINE SCREW	6
12	SCREEN LOCK	2
13	10-32 X 1.688 PHILLIPS PAN HEAD SCREW	2
14	38-16 X.75 LG BUTTON HEAD MACHINE SCREW	4
15	38-16 HEX NYLOCK NUT	4
16	#10 X .75 FLAT HEAD WOOD SCREW	12
17	#8 X .75 FLAT HEAD WOOD SCREW (IR)	4
18	6MM X 20 FLAT HEAD MACHINE SCREW	4
19	6MM X 12MM FLAT HEAD MACHINE SCREW	4
20	#6 X .75 ROUND HEAD WOOD SCREW (RF)	2
21	6MM X 16 BUTTON HEAD MACHINE SCREW	4

### L-27 TV Lift System with Hardware

## Supplemental Page B: Setting a Height Limit

Please follow this procedure if you would like to limit the distance that your TV Lift extends.

### To set your Travel Limit with IR Controls:

If you want the lift system to always go to its full extension, do NOT use the Height Limit Insert. Simply leave it unplugged and the system will always travel to the full extension. To limit the travel, follow the procedure below:



1. Using the IR Receiver, run the lift system to height limit position and stop it there.
2. With the lift system stopped, plug the Height Limit Insert into the available RJ45 port on the Control Box. This will set the height limit at this position for both the IR Remote (or 3<sup>rd</sup> party universal remote) and the IR Receiver.
3. If the height limit is set at the incorrect position, remove the Height Limit insert and repeat the procedure.

### To set your Travel Limit with RF Controls:

If you want the lift system to always go to its full extension, do NOT use the Height Limit Insert. Simply leave it unplugged and the system will always travel to the full extension. To limit the travel, follow the procedure below:

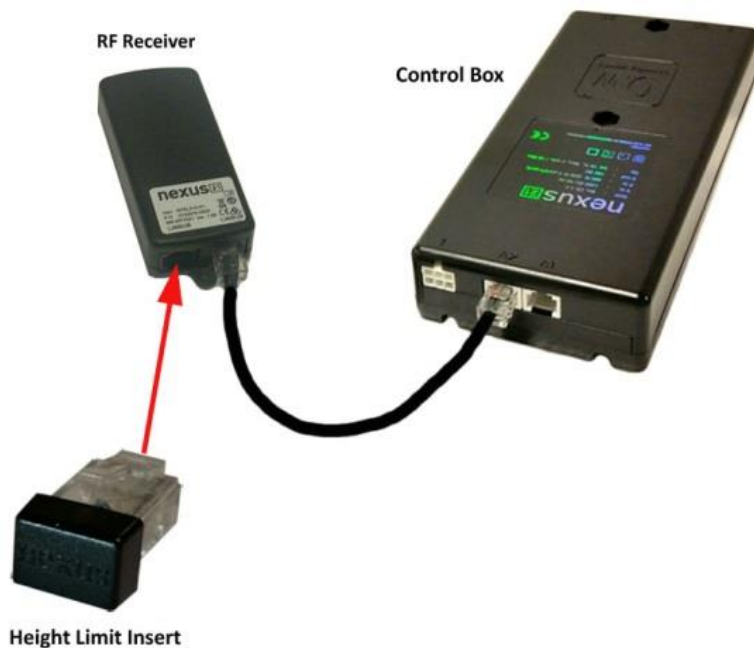

1. Using the Wired Backup Switch, run the lift system to the ideal height limit position and stop it there.
2. With the lift system stopped, plug the Height Limit Insert into the available RJ45 port on the RF Receiver. This will set the height limit at this position for both the RF Remote and Backup Switch.
3. If the height limit is set at the incorrect position, remove the Height Limit insert and repeat the procedure.

# Supplemental Page C: Connect the Lift to Home Control System

## Connecting the Nexus 21 Lift System to Other Control Systems

Use these instructions if you need to wire the Lift System directly to a Home Control System, like those made by Crestron, AMX, Control 4, RTI, etc. A common term for this method of integration is “connection by contact closure.”

### Contents of Contact Closure Hardware Pack:

#### Step 1: Contact Closure Hardware Pack

This pack contains the following parts:

- 1 – Contact Closure Cable, RJ-45 to Relays
- 1 – Height limit Insert



Contact Closure Cable, RJ-45 to Relays



Height Limit Insert

#### Step 2: Connecting the Lift System to the Control System

Using the *Contact Closure Cable* to connect the three wires directly to the relays on your control module (see image below). Then connect the RJ-45 plug on the *Contact Closure Cable* to the Nexus 21 system, using either one of the two RJ-45 ports on the side of the Nexus 21 Control Box.

#### The colored wires function as follows:

**BLUE** = common (Pin 4 from RJ45) **GREEN** = Extend (Pin 5 from RJ45) **RED** = Retract (Pin 8 from RJ45)

#### Wire combinations for the relays:

The lift system uses two relays. One for “extend” and one for “retract.” The common wire runs between both relays, by using the **BLUE common wire**, together with a jumper wire you supply.

- Relay 1 Extend: **BLUE** common wire with **GREEN** normally open.
- Relay 2 Retract: **BLUE** common wire (use jumper) with **RED** normally open.



Close-up View of RJ-45 Pins

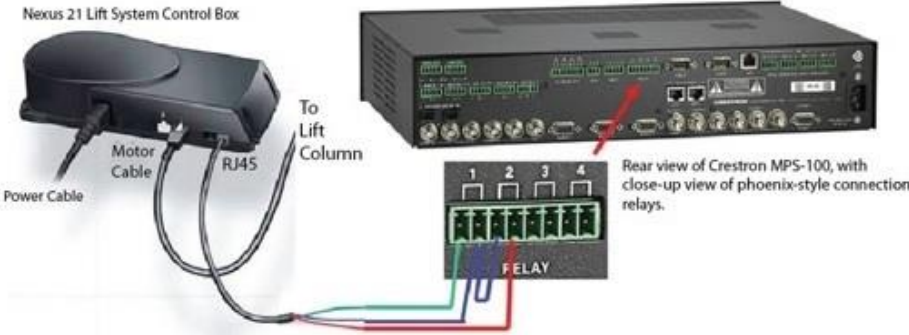

#### Step 3: Setting a Height Limit for the Lift System

Begin with the Height Limit Insert UNPLUGGED. Then send the “UP” command from your control system and run the Lift System up to your desired height. Once the Lift System is at the desired height, send the “DOWN” command to stop the lift at the point. Now PLUG the Height Limit Insert into the available RJ45 port on the Nexus 21 Control Box. The Lift will now remember the height and always stop at that point. To change, unplug the Height Limit Insert and repeat Step 3.

For technical support or to ask questions, call Nexus 21 Customer Service, toll-free at (866) 500-5438.

**How to Properly Install a Lid "Catch" with a Nexus 21 Lift System**

There are multiple ways to properly create a "catch" for the lid to rest on, when the lift is in the fully retracted position. Down below are a few examples.

Using the provided Lid Catch Brackets with (8) #10 x 3/4" THWS attach the brackets to each corner of the lid opening. This will provide a support point for the lid to rest on while the lift is in the fully retracted position, assuring the lid is flush with the rest of the cabinetry every time.

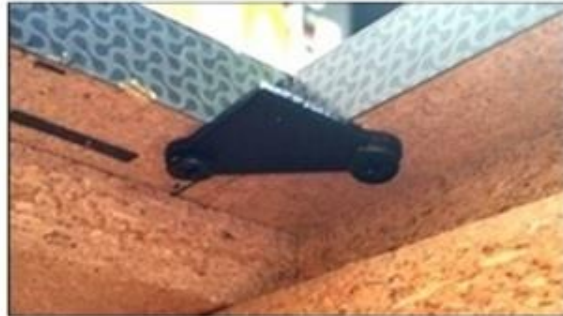

Here are a few other examples on how to create a "catch" or "lip" for the cabinet lid to rest upon.

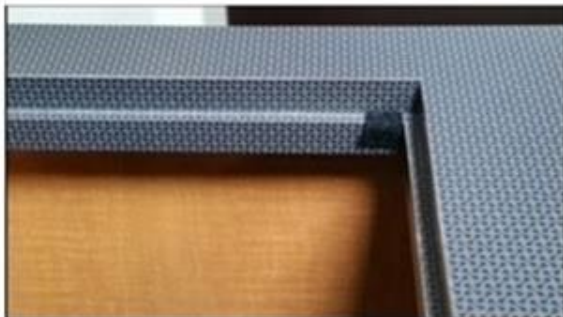

**nexus**   
CONCEALMENT SYSTEMS  
866.500.5438