

SONOROUS

PRODUCT INFORMATION

**ELEMENTS MULTIMEDIA CABINETS
FLOOR CABINETS**

160 x 40 CM (WITH HOLE)

EX30FF

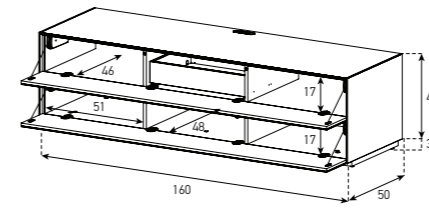

EX30TC / PC
(Adjustable shelf + 4 cm)

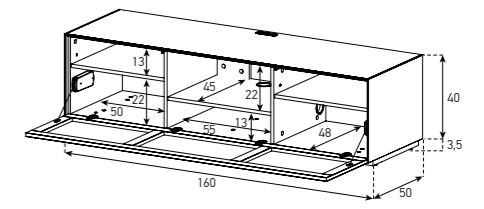

EX30TS / PS

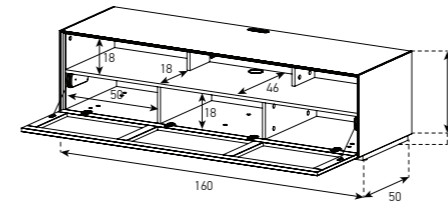

EX30F
(Adjustable shelf + 4 cm)

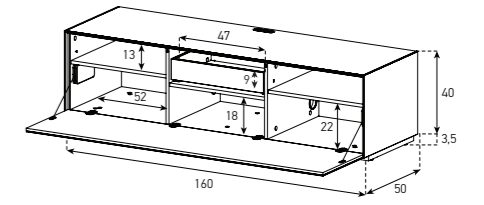

EX30-PF

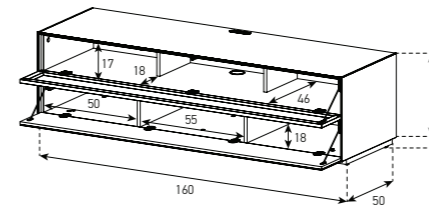

160 x 40 CM (WITH HOLE & BRACKET)

EX31F
(Adjustable shelf + 4 cm)

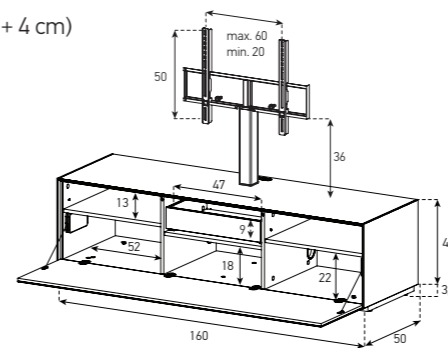

EX31TC / PC
(Adjustable shelf + 4 cm)

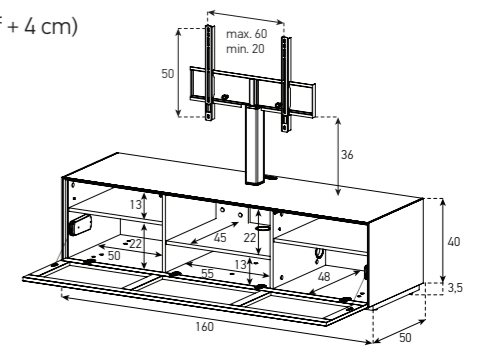

EX31TS / PS

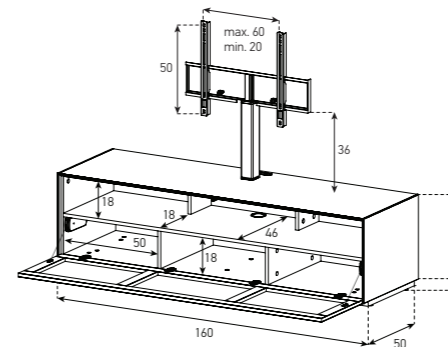

EX31FF

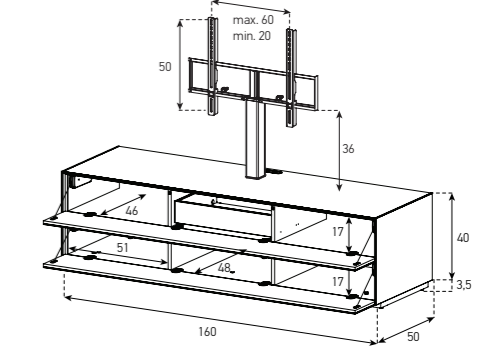

EX31PF

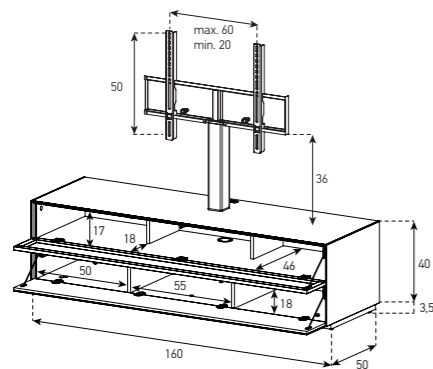

160 x 40 CM (WITHOUT HOLE)

EX32F
(Adjustable shelf + 4 cm)

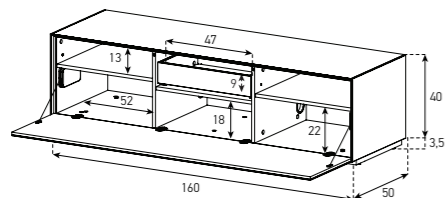

EX32TS / PS

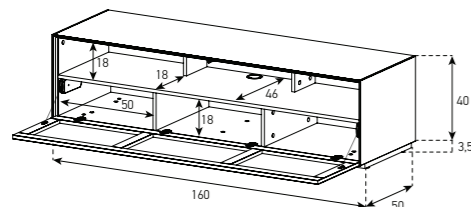

EX32PF

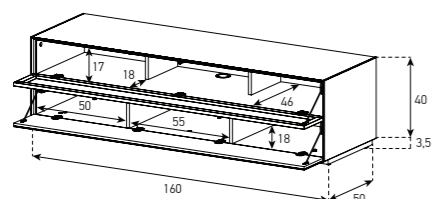

EX32TC / PC
(Adjustable shelf + 4 cm)

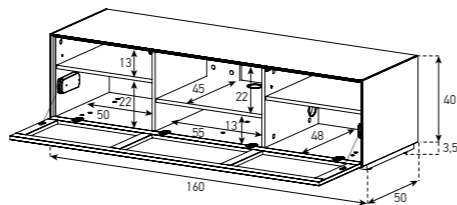

EX32FF

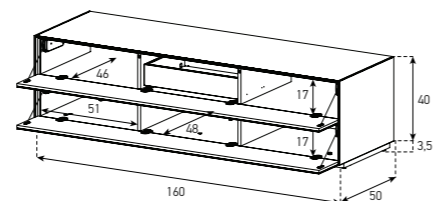

130 x 40 CM (WITH HOLE)

EX10DD

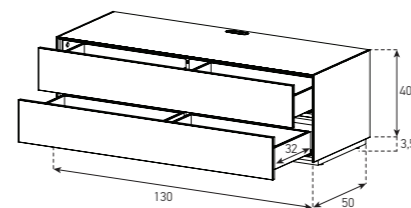

EX10FD

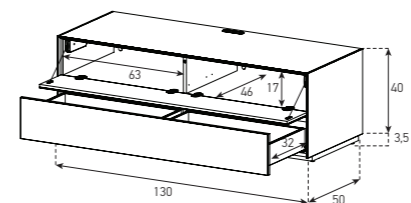

EX10TC / PC

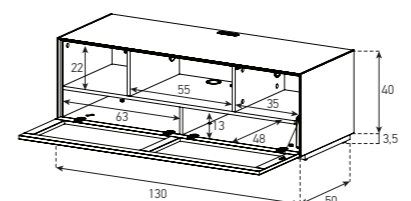

EX10TF / PF

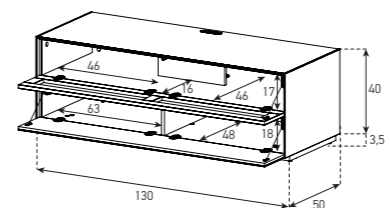

EX10TT / PP

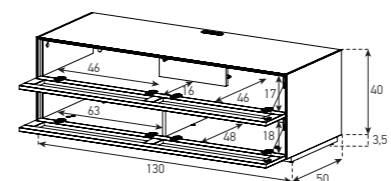

EX10F
(Adjustable shelf + 4 cm)

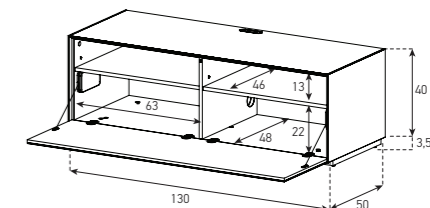

EX10FF

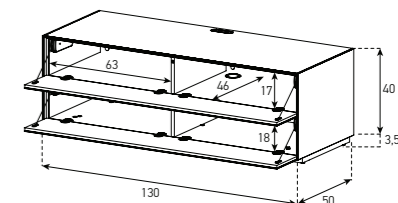

EX10TD / PD

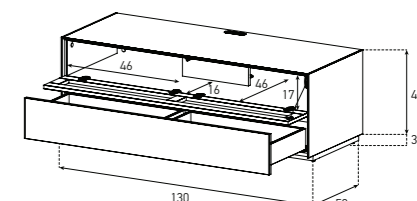

EX10TS / PS

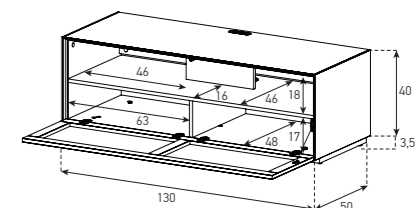

130 x 40 CM (WITH HOLE & BRACKET)

EX11DD

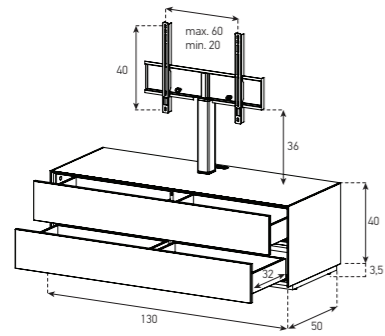

EX11F
(Adjustable shelf + 4 cm)

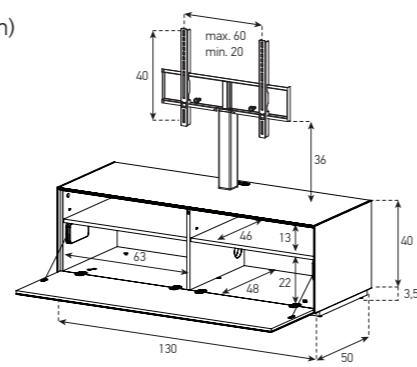

EX11FD

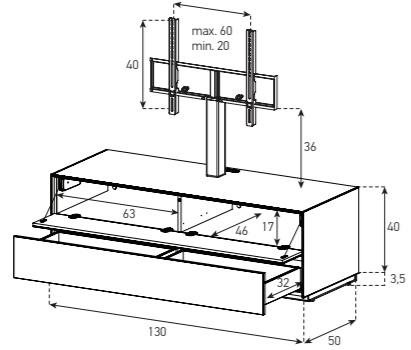

EX11FF

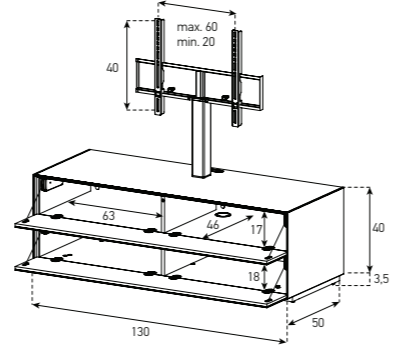

EX11TD / PD

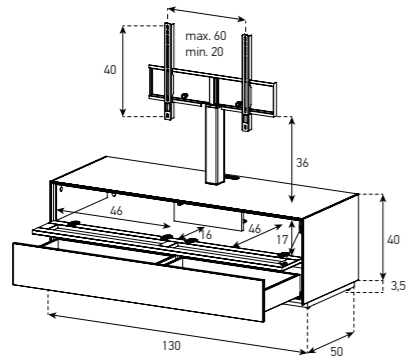

EX11TF / PF

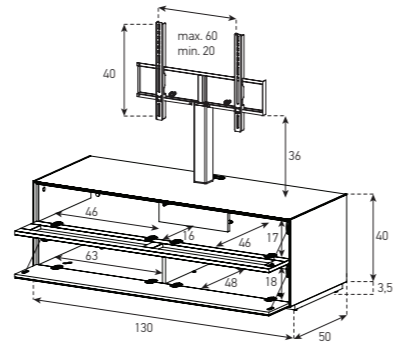

EX11TS / PS

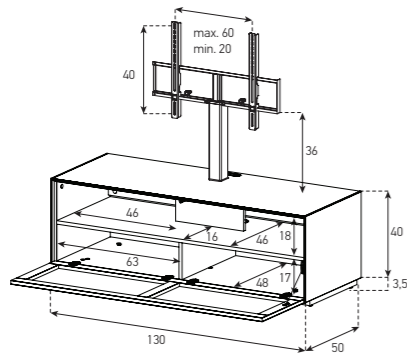

EX11TT / PP

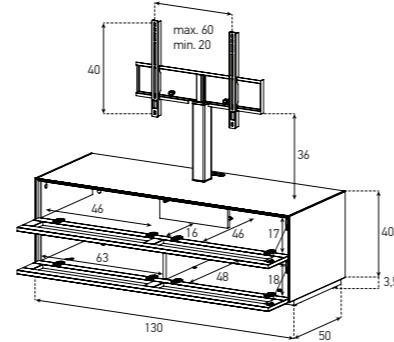

130 x 40 CM (WITHOUT HOLE)

EX12DD

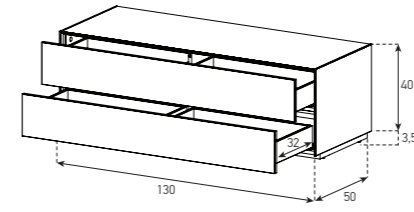

EX12F
(Adjustable shelf + 4 cm)

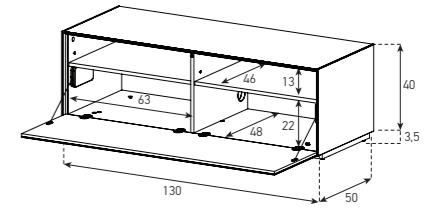

EX12FD

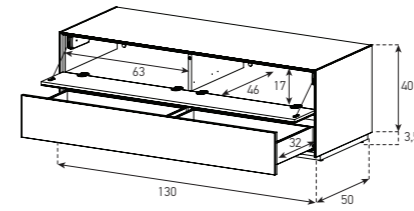

EX12FF

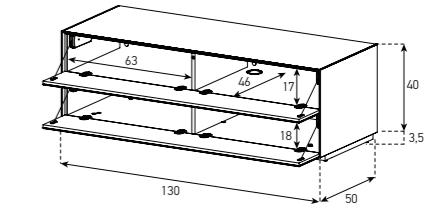

EX12TC / PC

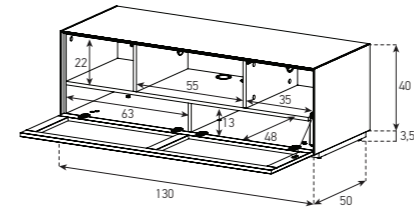

EX12TD / PD

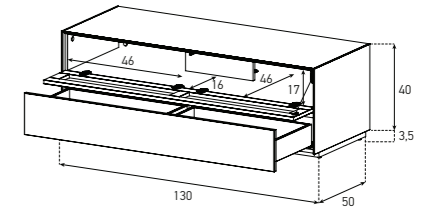

EX12TF / PF

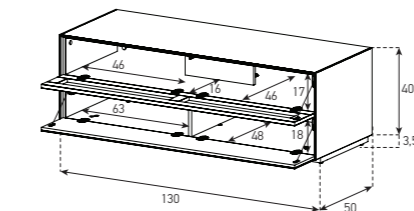

EX12TS / PS

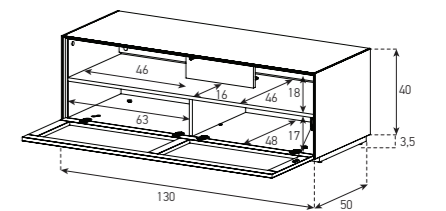

EX12TT / PP

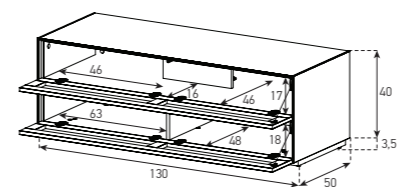

160 x 25 CM (WITH HOLE)

EX35F

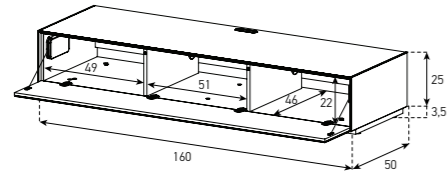

EX35TS / PS

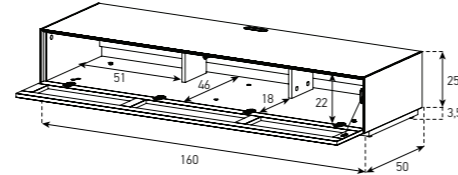

160 x 25 CM (WITH HOLE & BRACKET)

EX36F

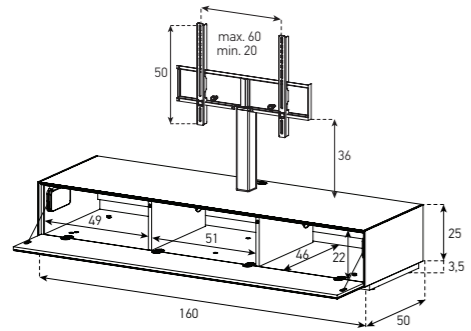

EX36TS / PS

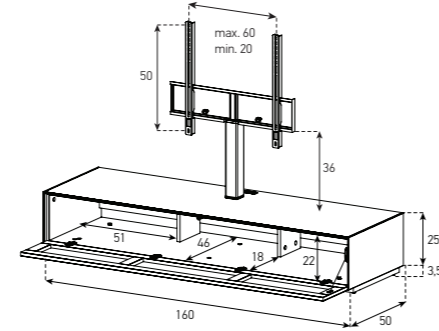

160 x 25 CM (WITHOUT HOLE)

EX37F

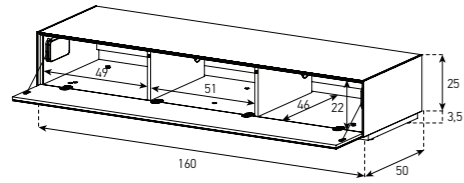

EX37TS / PS

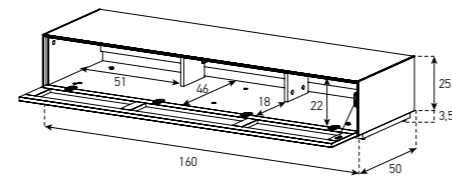

FLOOR CABINETS 130 x 25 CM (WITH HOLE)

EX15D

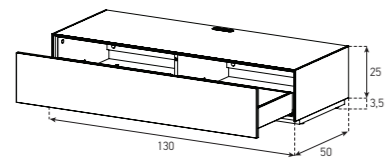

EX15F

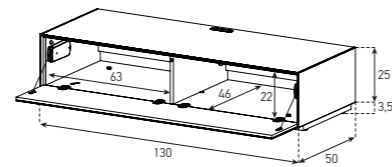

EX15TS / PS

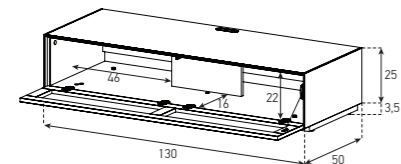

130 x 25 CM (WITH HOLE & BRACKET)

EX16D

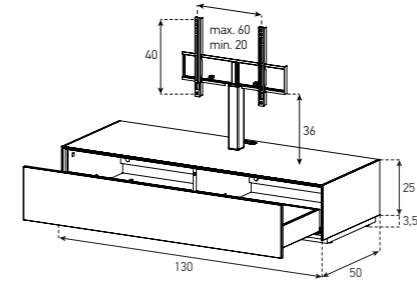

EX16F

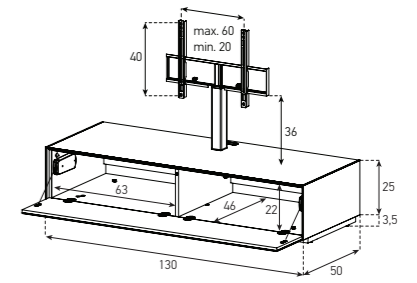

EX16TS / PS

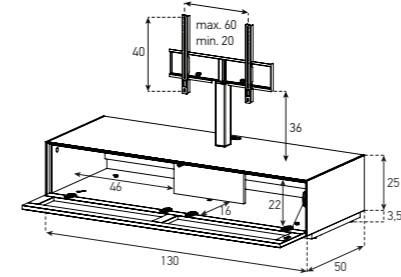

130 x 25 CM (WITHOUT HOLE)

EX17D

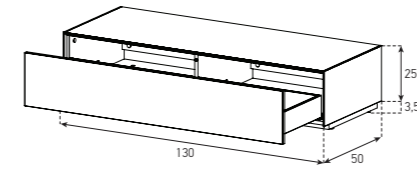

EX17TS / PS

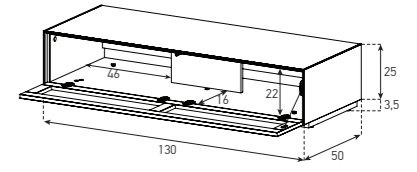

EX17F

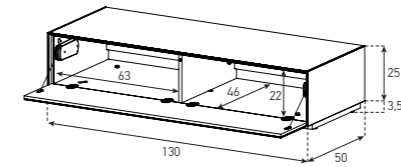

65 x 40 CM

EX20D
(Adjustable shelf + 4 cm)

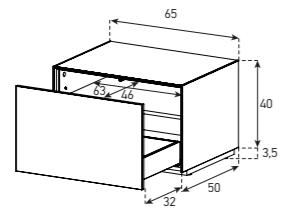

EX20DD

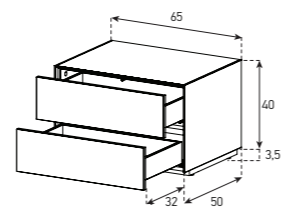

EX20F
(Adjustable shelf + 4 cm)

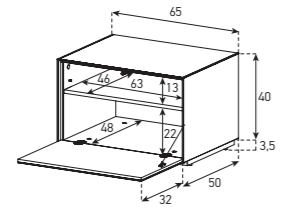

EX20FD

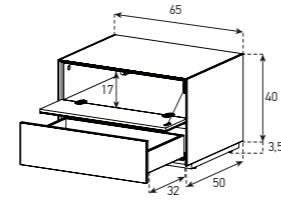

EX20FF

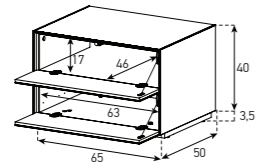

EX20TS / PS
(Adjustable shelf + 4 cm)

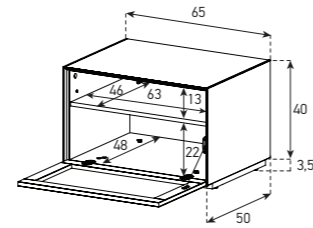

ER01F
FOR TURN TABLE

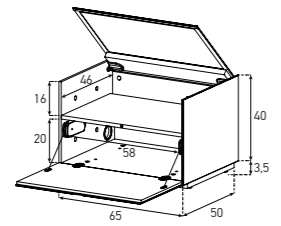

EM01F
FOR MOBILE DEVICE

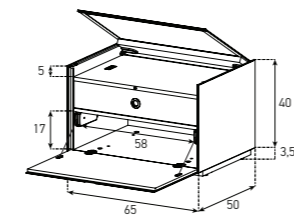

FLOOR CABINETS (65 x 25 CM)

EX25D

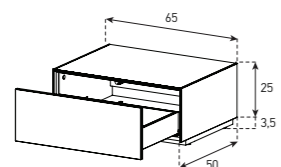

EX25F

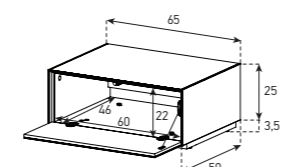

WALL UNITS (160x40 CM)

ED30F

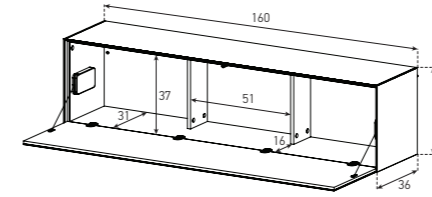

ED30U

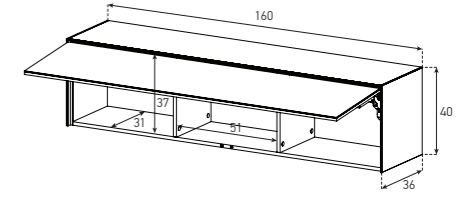

ED30TS / PS

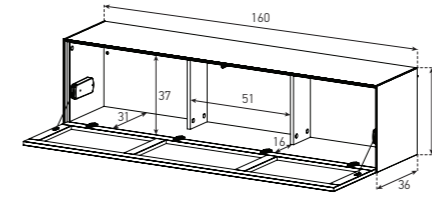

ED31F (WITH CABLE MANAGEMENT)

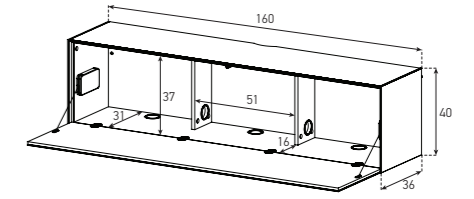

ED31TS / PS (WITH CABLE MANAGEMENT)

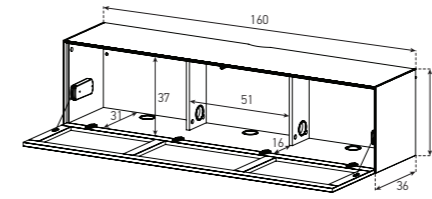

WALL UNITS (160x25 CM)

ED35F

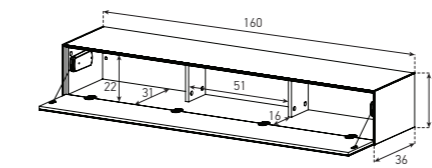

ED35TS / PS

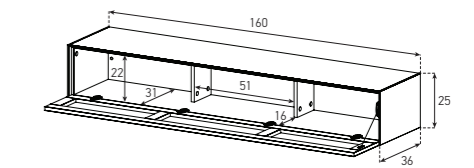

ED36F (WITH CABLE MANAGEMENT)

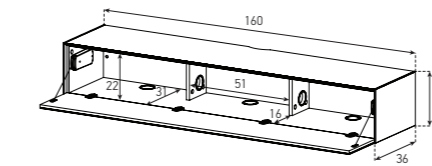

ED36TS / PS (WITH CABLE MANAGEMENT)

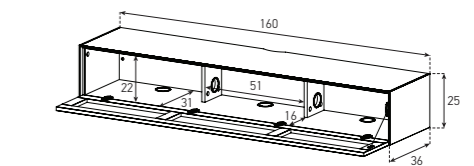

WALL UNITS 130 x 40 CM

ED60F

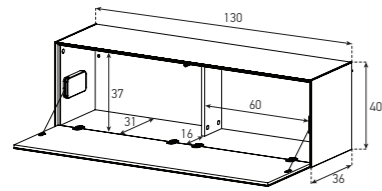

ED60U

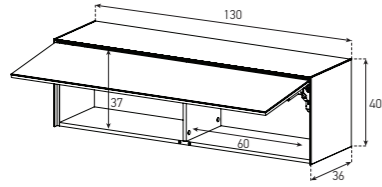

ED61TS / PS (WITH CABLE MANAGEMENT)

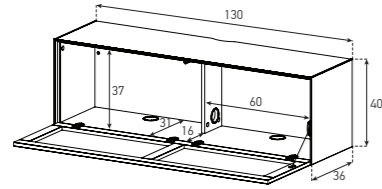

ED60TS / PS

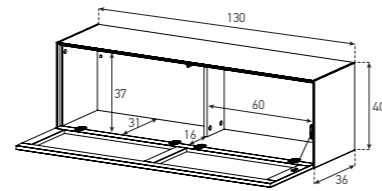

ED61F (WITH CABLE MANAGEMENT)

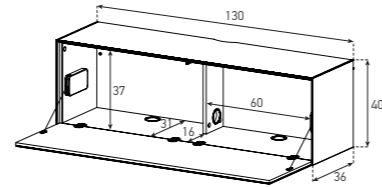

WALL UNITS 130 x 25 CM

ED65F

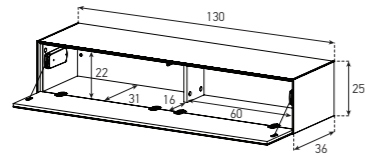

ED66F (WITH CABLE MANAGEMENT)

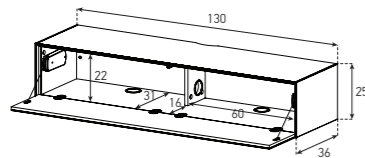

ED65TS / PS

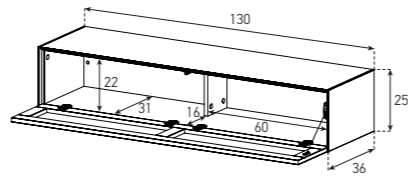

ED66TS / PS (WITH CABLE MANAGEMENT)

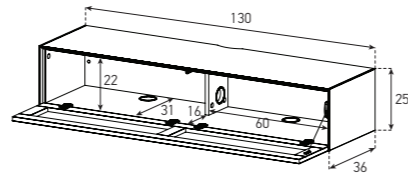

ED70DR / DL
(Adjustable shelf +/- 6 cm)

40 x 100 CM

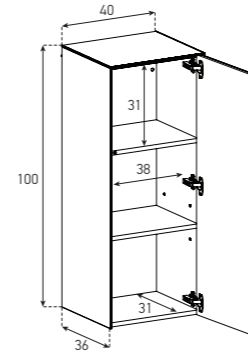

ED75DR / DL
(Adjustable shelf +/- 6 cm)

25 x 100 CM

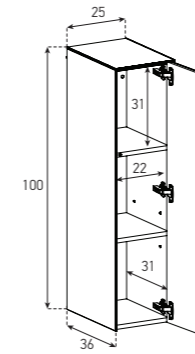

ED71DR / DL
(Removable shelf)

40 x 100 CM

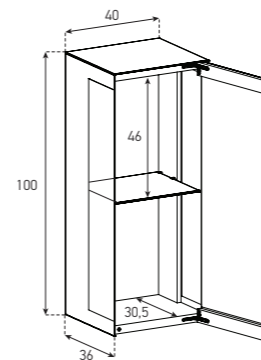

ED80DR / DL
(Adjustable shelf +/- 6 cm)

40 x 130 CM

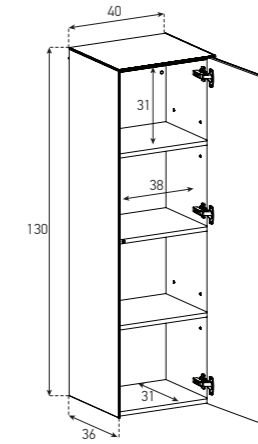

ED85DR / DL
(Adjustable shelf +/- 6 cm)

25 x 130 CM

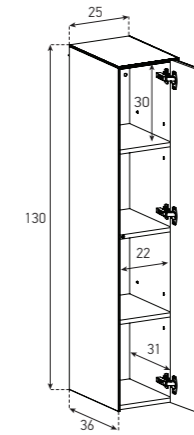

ED81DR / DL
(Removable shelf)

40 x 130 CM

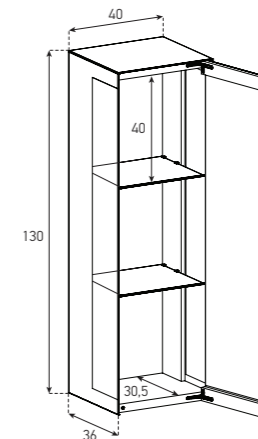

ED90DR / DL
(Adjustable shelf +/- 6 cm)

40 x 160 CM

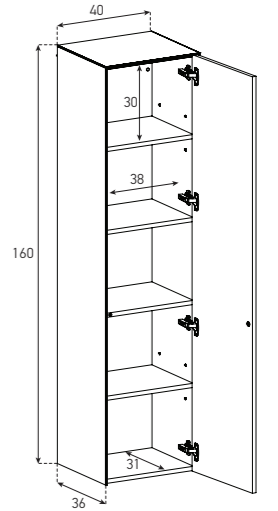

ED95DR / DL
(Adjustable shelf +/- 6 cm)

25 x 160 CM

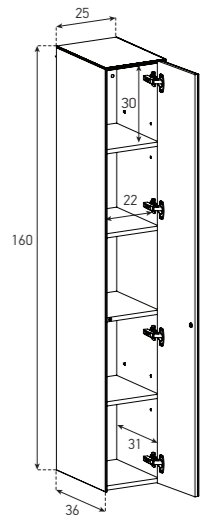

ED91DR / DL
(Removable shelf)

40 x 160 CM

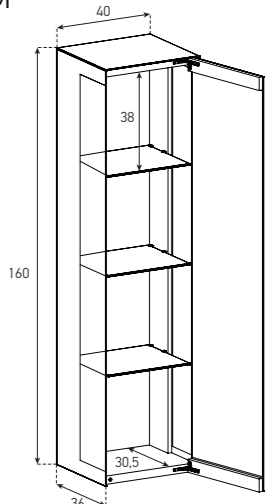

ED76DR / DL
(Removable shelf)

25 x 100 CM

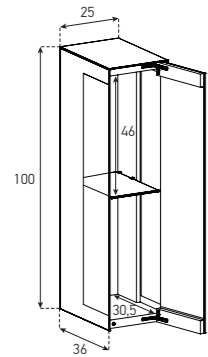

ED86DR / DL
(Removable shelf)

25 x 130 CM

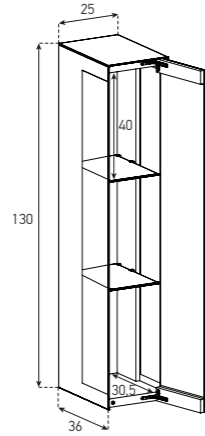

ED96DR / DL
(Removable shelf)

25 x 160 CM

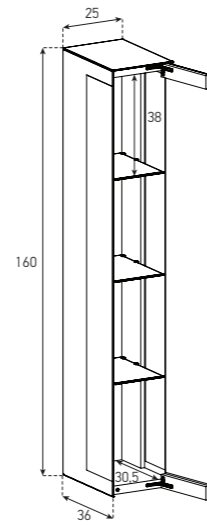

ED 50F

65 x 40 CM

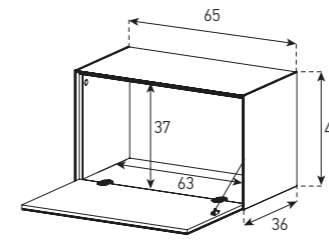

ED 55-F

65 x 25 CM

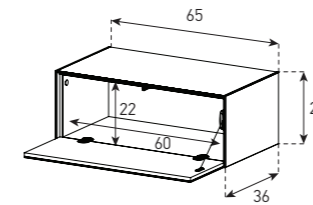

ED50U

65 x 40 CM

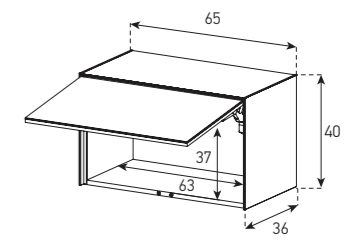

OP40

40 X 40 CM

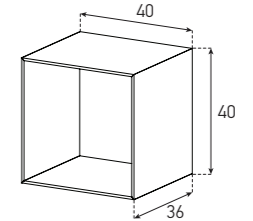

WALL UNITS (Open cabinets can be hang either vertical or horizontal)

OP70V (vertical)
OP70H (horizontal)

40 x 100 CM

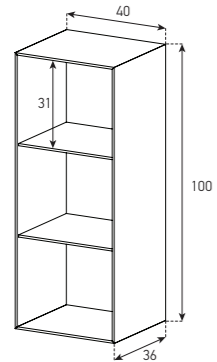

OP80V (vertical)
OP80H (horizontal)

40 x 130 CM

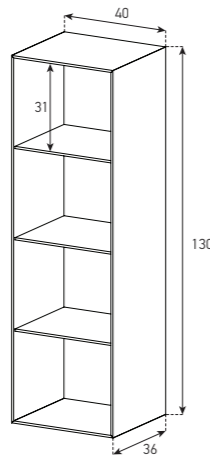

OP90V (vertical)
OP90H (horizontal)

40 x 160 CM

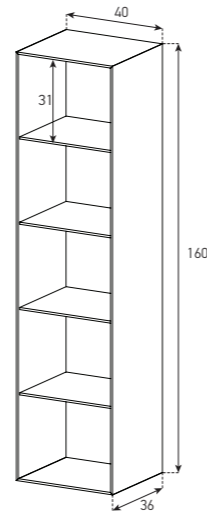

OP75V (vertical)
OP75H (horizontal)

25 x 100 CM

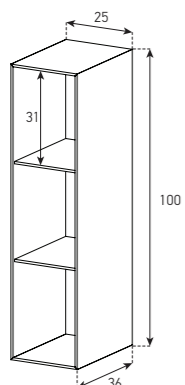

OP85V (vertical)
OP85H (horizontal)

25 x 130 CM

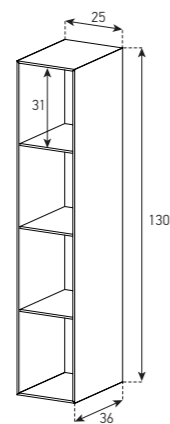

OP95V (vertical)
OP95H (horizontal)

25 x 160 CM

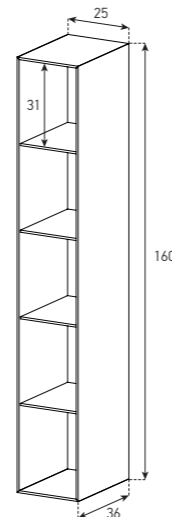

OP50V (vertical)
OP50H (horizontal)

65 X 40 CM

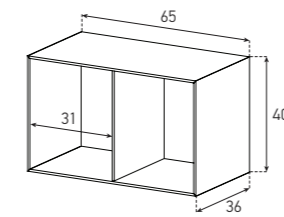

OP55V (vertical)
OP55H (horizontal)

65 X 25 CM

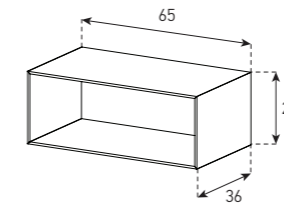

OP45V (vertical)
OP45H (horizontal)

25 X 40 CM

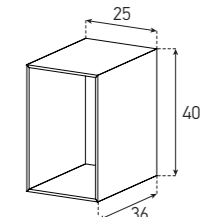

ACCESSORIES

AL-HECD
CD Organizer

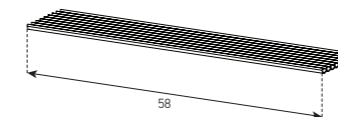

AL-HEDVD
DVD Organizer

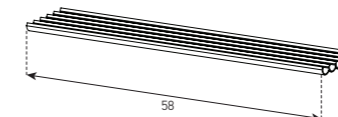

IR 3000
Infrared Repeater

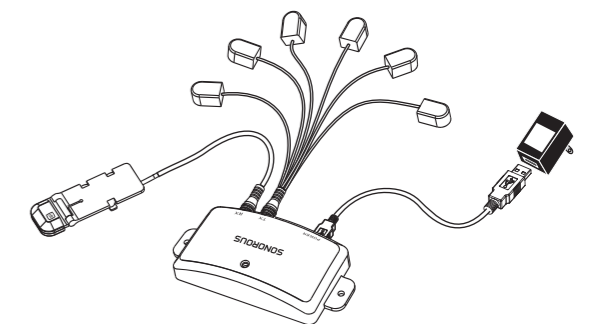

**ELEMENTS CODE SAMPLE
(Floor Cabinets)**

EX10FF-WHT-WHT-CG2BLKA

1 2 3 4 5 6 7

1) Cabinet Types

EX30 (With Hole)
EX31 (With Hole & Bracket)
EX32 (Without Hole)



EX10 (With Hole)
EX11 (With Hole & Bracket)
EX12 (Without Hole)

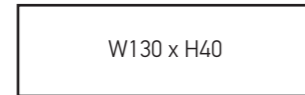

EX20



ER01
EM01

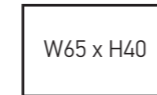

EX35 (With Hole)
EX36 (With Hole & Bracket)
EX37 (Without Hole)

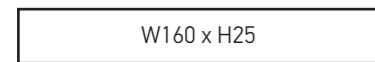

EX15 (With Hole)
EX16 (With Hole & Bracket)
EX17 (Without Hole)



EX25

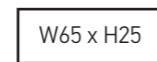

2) Cabinet Doors :

F

(Flap Down)

D

(Drawer)

FF

(Flap Down&Flap Down)

FD

(Flap Down & Drawer)

DD

(Drawer & Drawer)

TS

(Textile - Soundbar compatible body)

TC

(Textile - Center speaker compatible body)

TT

(Textile & Textile)

TF

(Textile & Flap down)

TD

(Textile & Drawer)

PS

(Perforated - Soundbar compatible body)

PC

(Perforated - Center speaker compatible body)

PP

(Perforated & Perforated)

PF

(Perforated & Flap down)

PD

(Perforated & Drawer)

3) Cabinet Colors & Decors : "Category (A, A+, B & F) " (F can produce only without hole)

4) Door Colors & Decors : "Category (A, A+, B, C, D, E & F) "

5) Base Options :

2 (3,5cm Base)	CG2 (Max.160cm) (20cm Metal Cage)	CRB (13cm Metal Crab)	S20 (130 & 160cm) (20cm Metal Spike)	S13 (130 & 160cm) (13cm Metal Spike)
-------------------	--------------------------------------	--------------------------	---	---

8 (9cm Base)	CG4 (Max.130cm) (40cm Metal Cage)	TBE (130 & 160cm) (13cm Metal Tube)	PLN (130 & 160cm) (13cm Metal Plain)
-----------------	--------------------------------------	--	---

6) Base Colors : (Base 2 and 8 available only in silver) "Category (D) "

7) Structure Options :



**ELEMENTS CODE SAMPLE
(Wall Cabinets)**

ED50F-WHT-WHT-A

1 2 3 4 5

1) Cabinet Types

ED30
ED31 (With Cms*)



ED60
ED61 (With Cms*)



ED50
OP50

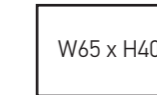

OP40

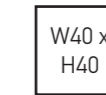

ED35
ED36 (With Cms*)

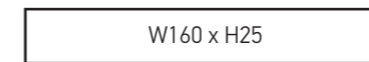

ED65
ED66 (With Cms*)



ED55
OP55



OP45

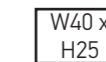

ED90
ED91
OP90

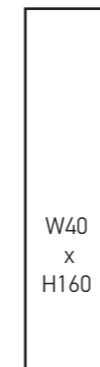

ED80
ED81
OP80

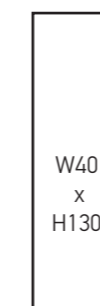

ED70
ED71
OP70

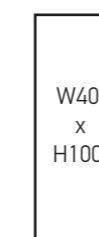

ED95
ED96
OP95



ED85
ED86
OP85



ED75
ED76
OP75



*CMS : Cable Management System

2) Cabinet Doors :

OP Type cabinets doesn't have door.

F

(Flap Down)

U

(Flap Up)

DR

(Door - Right Opening)

DL

(Door - Left Opening)

TS

(Textile - Soundbar compatible body)

PS

(Perforated - Soundbar compatible body)

3) Cabinet Color & Decors : "Category (A, A+, B, (Just B+ FOR OP) & F) " (F can produce only without hole)

4) Door Colors & Decors : "Category (A, A+, B, C, D, E & F) "

5) Structure Options :

Vertical wall units & Open cabinet wall units doesn't have structure option



5043

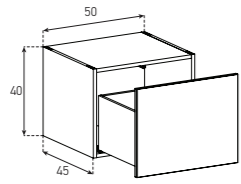

6543

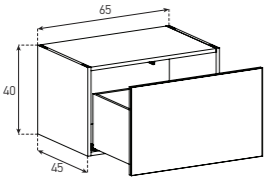

10043

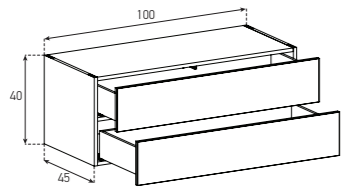

5061

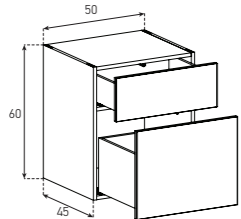

5063

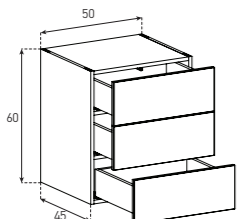

5044

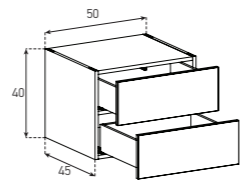

6544

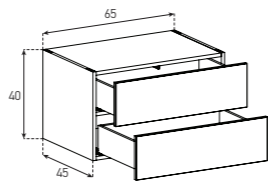

13043

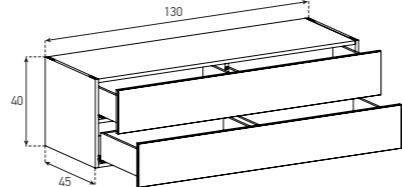

5062

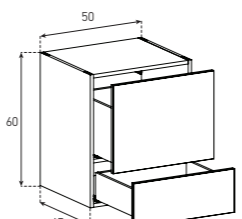

6561

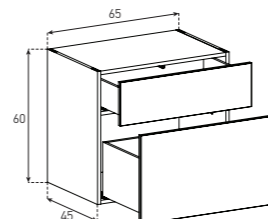

6562

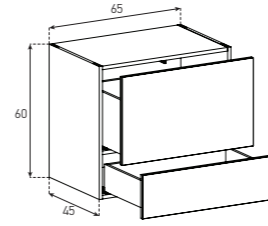

10061

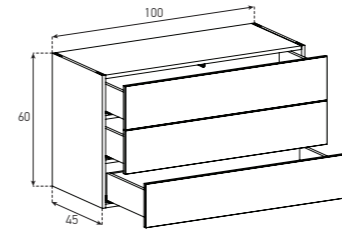

5082

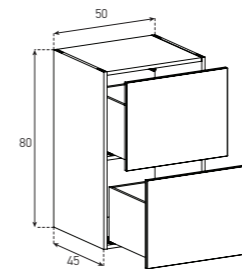

5084

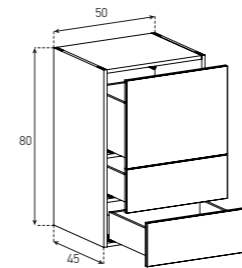

6582

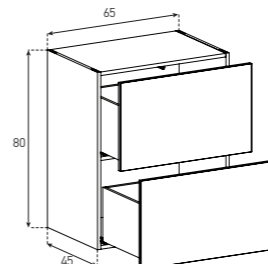

6563

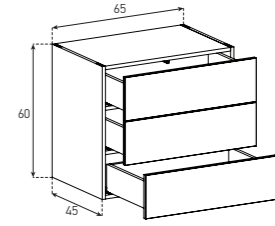

13061

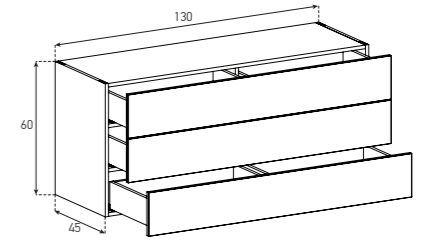

5083

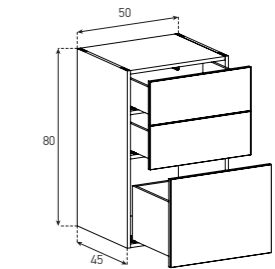

5085

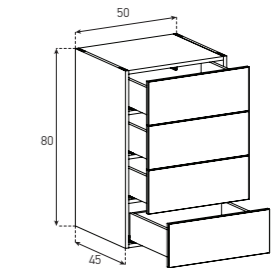

6583

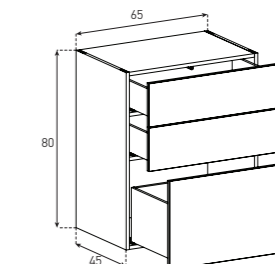

6584

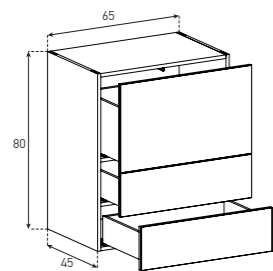

6585

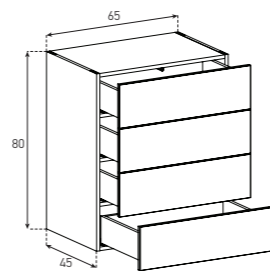

5064 R&L

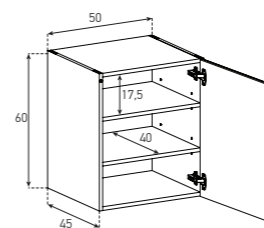

6566 R&L

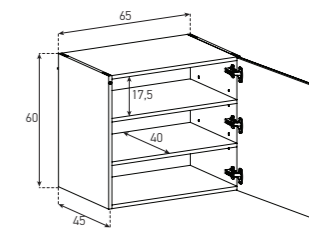

10082

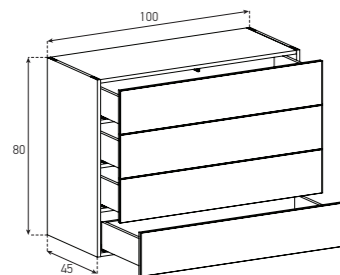

13082

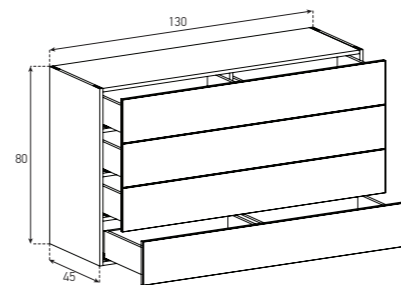

10062

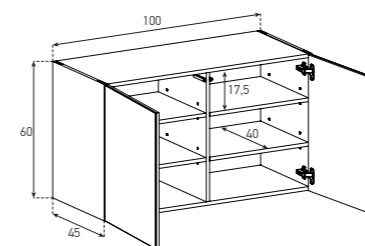

5086 R&L

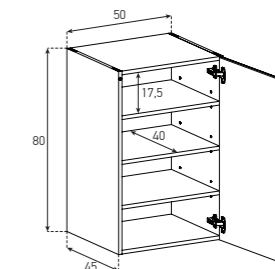

50101

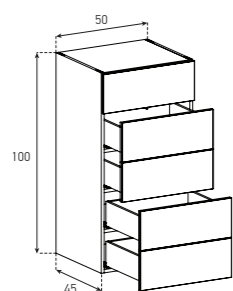

65101

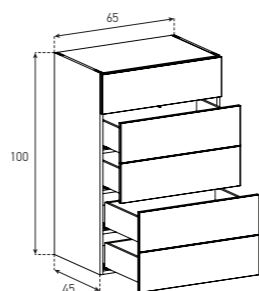

10083

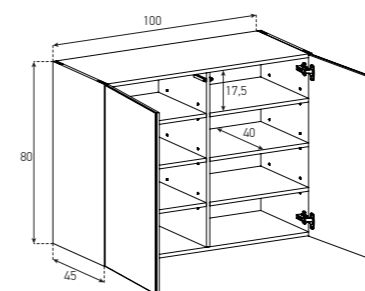

100101

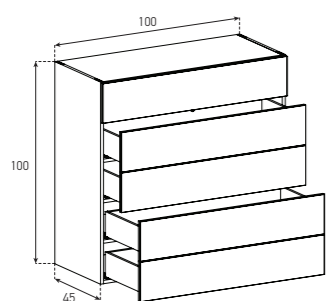

130101

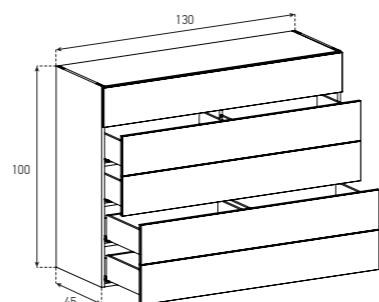

5164 R&L

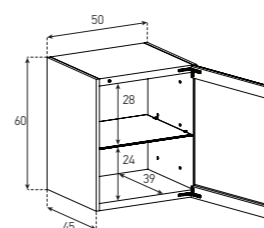

10162

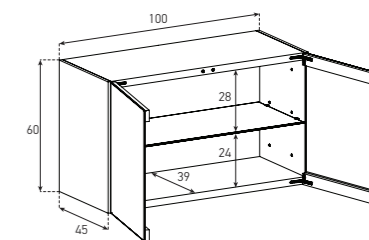

CABINET WITH DOOR

5045 R&L

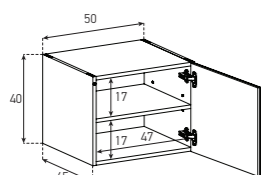

10044

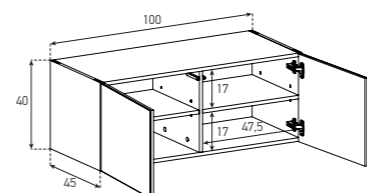

5186 R&L

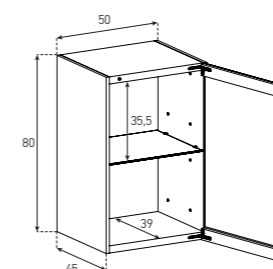

10183

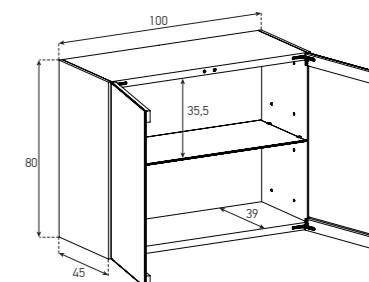

CABINET WITH FLAP DOWN

5041

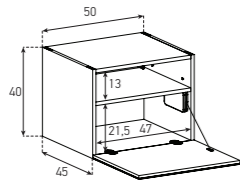

6541

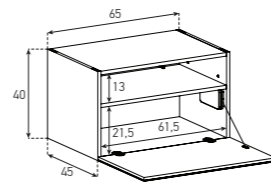

10081

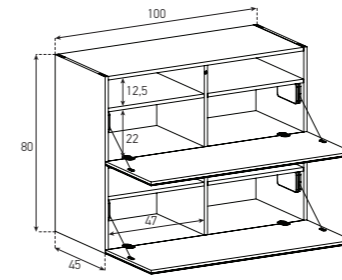

13081

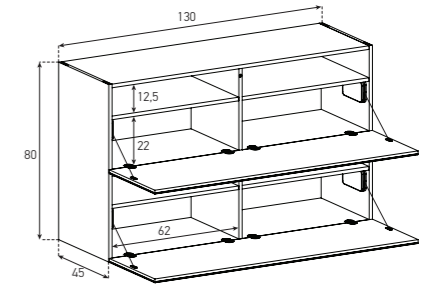

10041

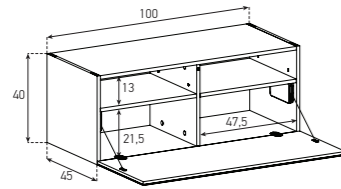

13041

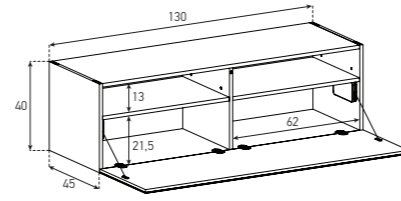

COMBO CABINETS

5046

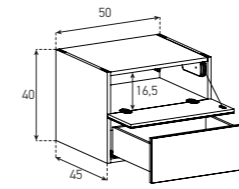

6545

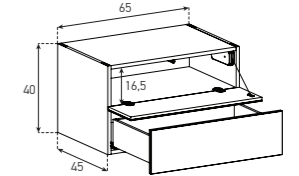

5042

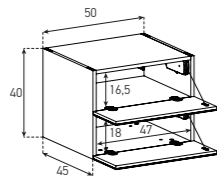

6542

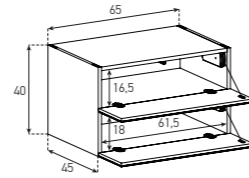

10045

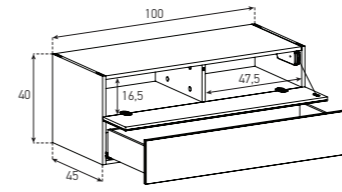

13044

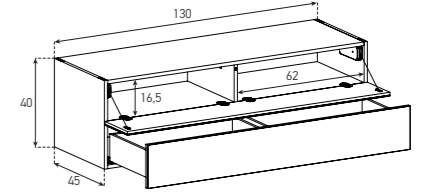

10042

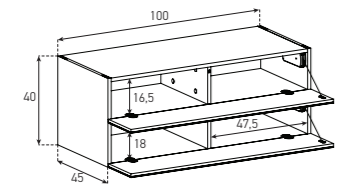

13042

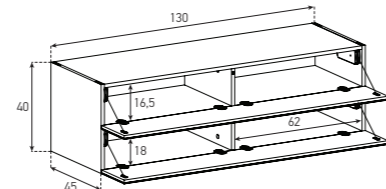

13044 T/P

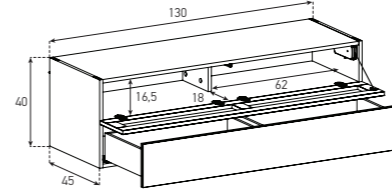

5065

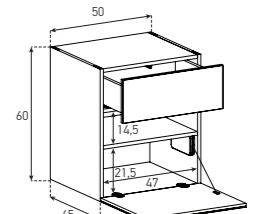

5081

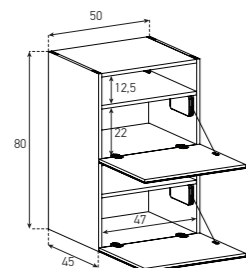

6581

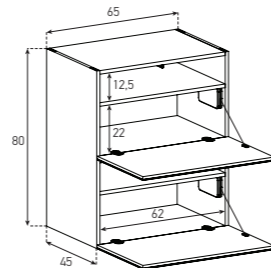

5066

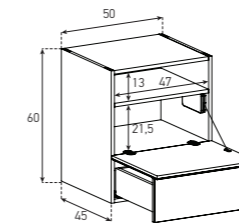

6564

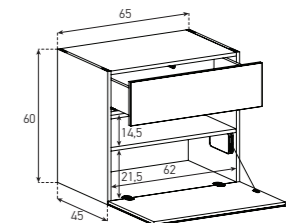

6565

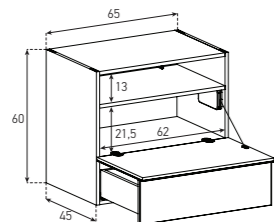

10063

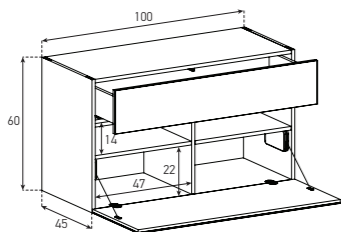

10064 T/P

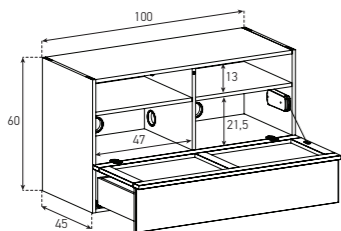

13063

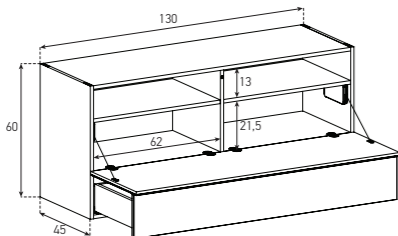

13064 T/P

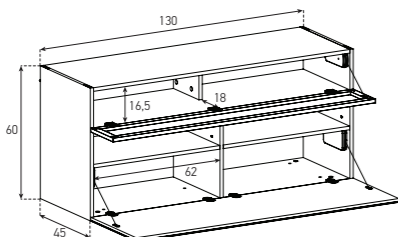

6567

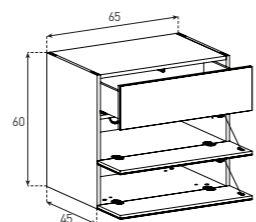

10064

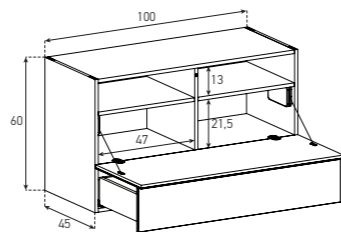

13062

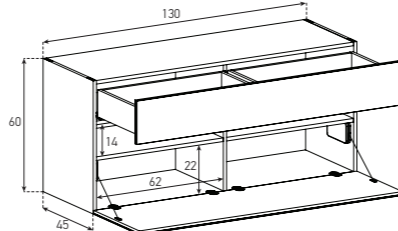

13063 T/P

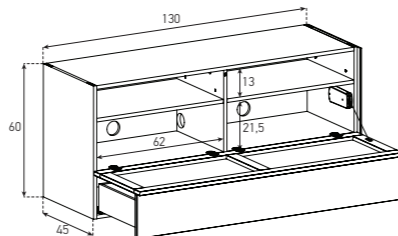

5087

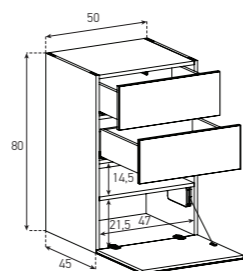

5088

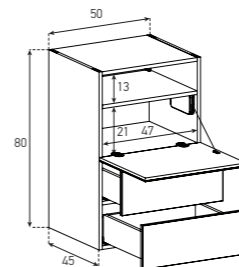

6586

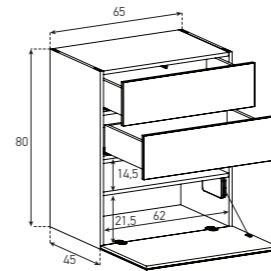

10084

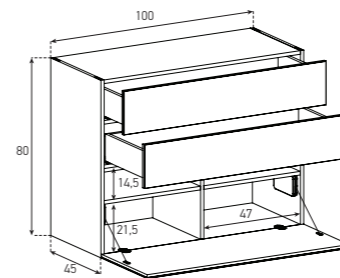

10085 T/P

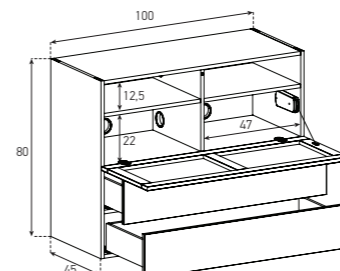

13083

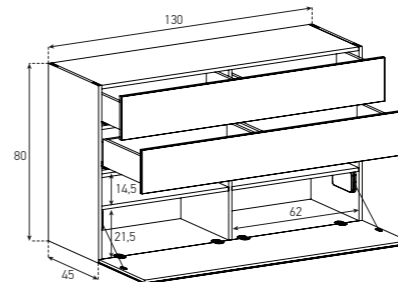

5089

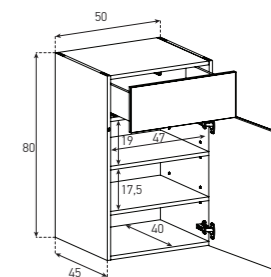

6587

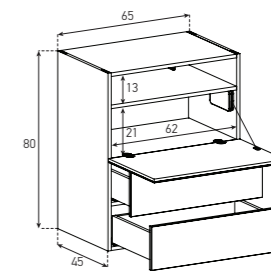

10085

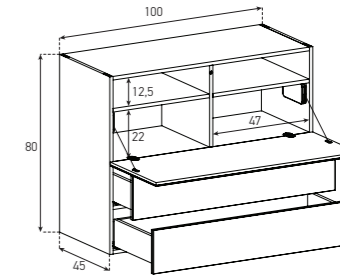

10086

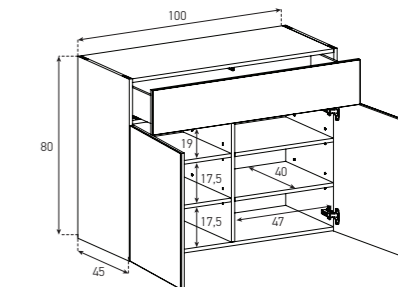

13084

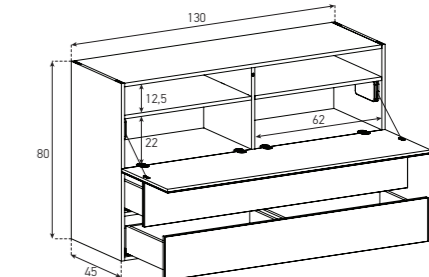

13084 T/P

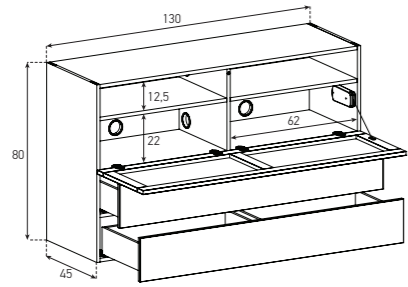

**SIDEBOARD
CODE SAMPLE**

SB-5061-WHT-BS-A(WHT)

1 2 3 4 5

BAR

100121

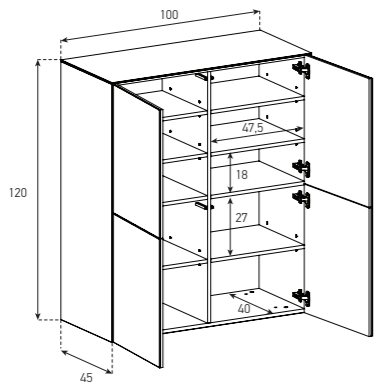

100122

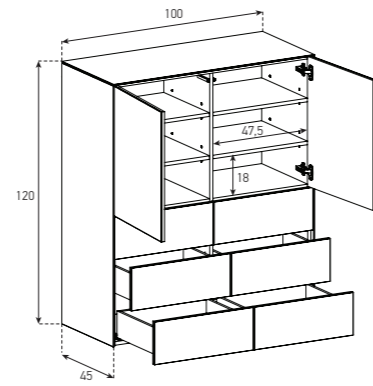

100123

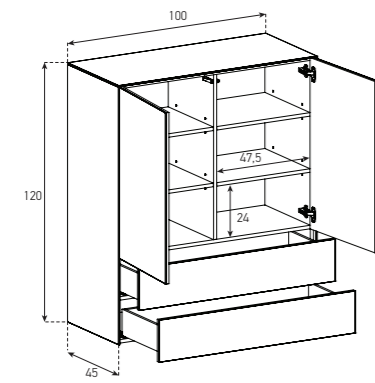

100124

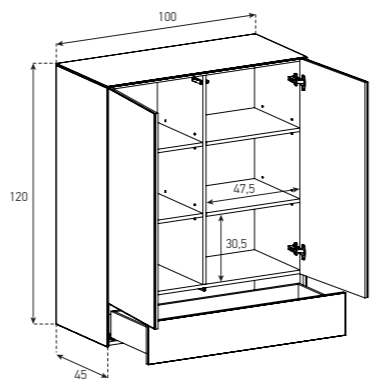

100125

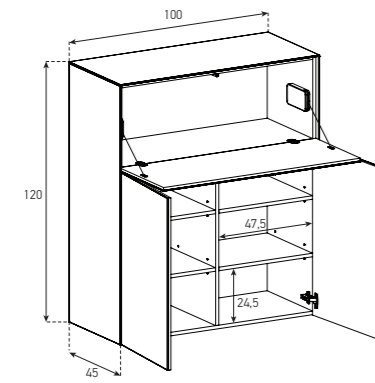

100126

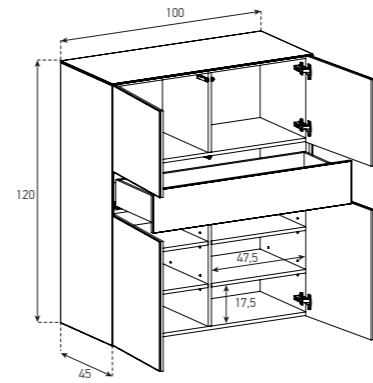

120121

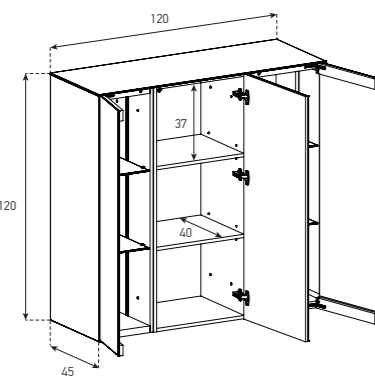

1) Cabinet Types :

	50cm	65cm	100cm	130cm
40cm	504#	654#	1004#	1304#
60cm	506#	656#	1006#	1306#
80cm	508#	658#	1008#	1308#
100cm	5010#	6510#	10010#	13010#



Total combination size can not exceed 260cm

2) Door Colors & Decors : "Category (A, A+, B, C, D, E & F)"

3) Base Options : "Category (D)"

BS (3,5cm Base)	CG2 (20cm Metal Cage)	CRB (13cm Metal Crab)	S20 (20cm Metal Spike)	S13 (13cm Metal Spike)
WL (Wall Hanging)	CG4 (40cm Metal Cage)	TBE (13cm Metal Tube)	PLN (13cm Metal Plain)	



5) Side Glass Colors : (D Type structure doesn't have side glass) "Category (A & A+)"

TOP GLASS CODE SAMPLE

SB-TG-WHT-195

TG = TOP GLASS GLASS COLOR SIZE* (CM)

METAL LEG CODE SAMPLE

SB-SPK-GRY-195

3 LEG COLOR SIZE* (CM)

1. Total length of combination
2. Bars can not be a part of combination

COFFEE TABLES

CTR-120G

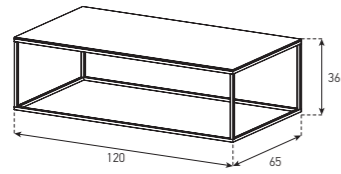

ES90D

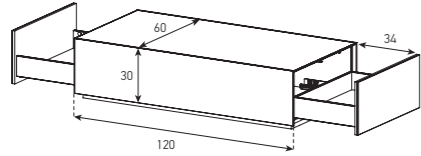

MAXI TRIPLE

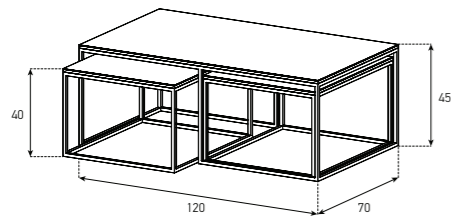

CT-SET 3

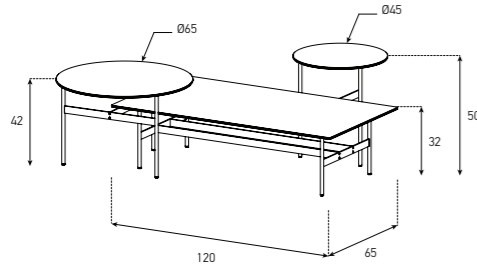

CT-SET4

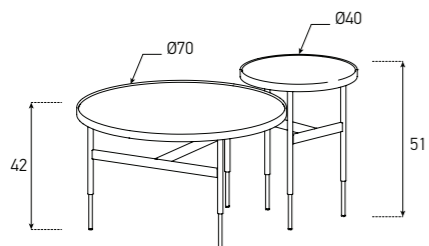

CTS-100G

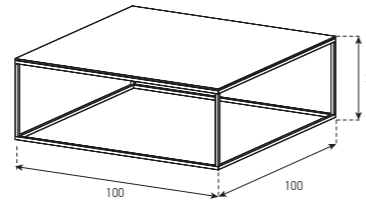

ES91D

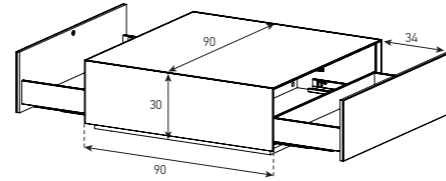

MAXI TRIPLE-A

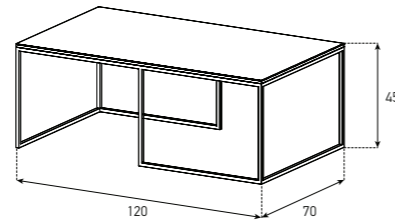

CT-SET3-A

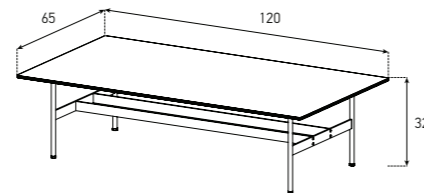

CT-SET4-A

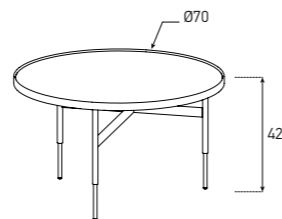

CT-SET 1

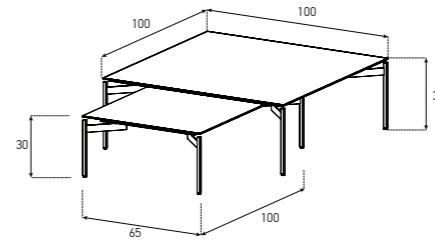

CT-SET1-A

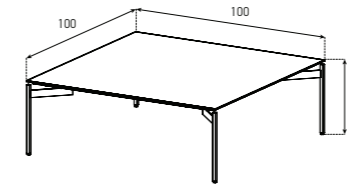

CT-SET2-BMR

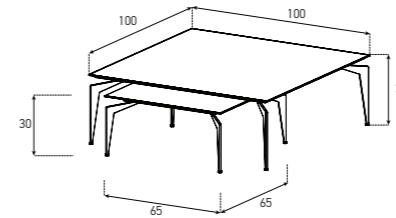

CTR-130C30

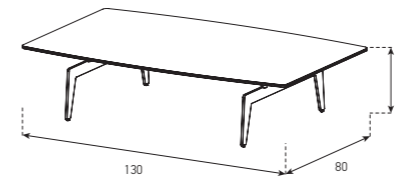

CT-SET2

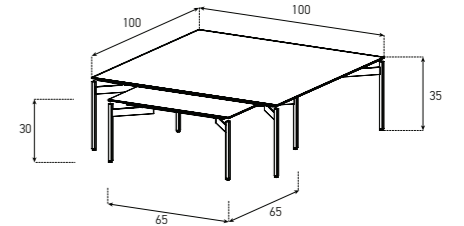

CT-SET1-BMR

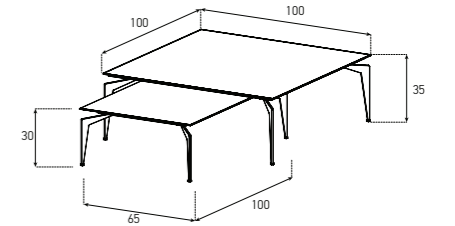

CT-SET1-BMR-A

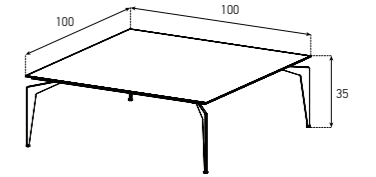

SABUL

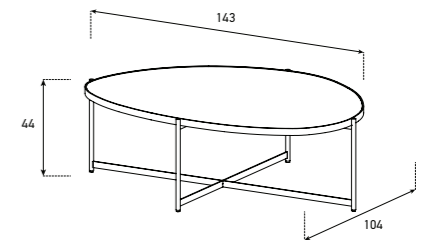

SIDE TABLES

MAXI TRIPLE-B

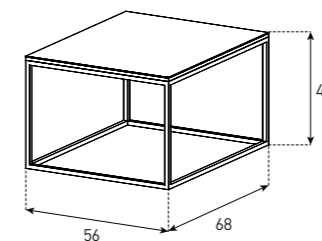

TRIPLE

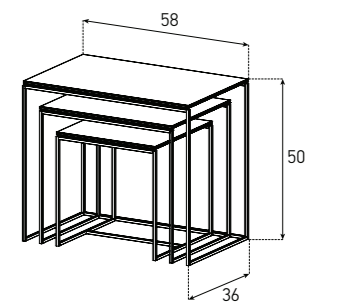

CT-SET2-B

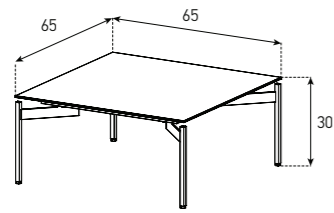

CT-SET2-BMR-B

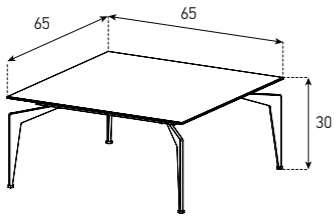

CT-SET3-B

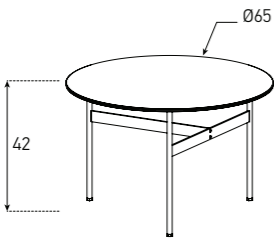

CT-SET4-B

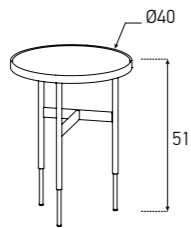

KL-49

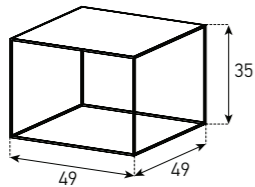

CT-SET1-B

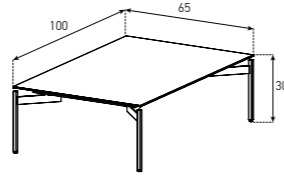

CT-SET1-BMR-B

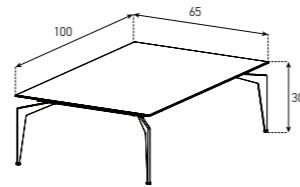

CT-SET3-C

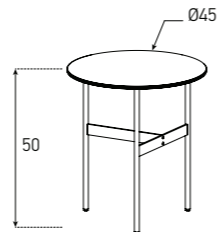

KL-42

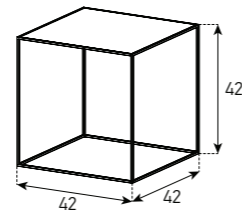

COFFEE TABLES AND SIDE TABLES
CODE SAMPLE

CTS-100G-WHT-GRY

1 2 3

1) Type :

2) Top Color & Decor : Page 68-71 "Category (A, A+ & F) "

3) Metal Leg Color : Page 68-71 "Category (D) "

Note : In case of set orders, encode different color and material preferences individually.

ES90D-WHT-WHT-CG2BLK

1 2 3 4 5

1) Cabinet Types

ES90D

ES91D

W120 x D60

W90 x D90

2) Cabinet Color & Decors : "Category (A, A+ & B) "

3) Door Color & Decors : "Category (A, A+, B, & F) "

4) Base Options :

2
(3,5cm Base)

CG2
(20cm Metal Cage)

5) Metal Leg Color : Page 68-71 "Category (D) "

DINING TABLES

TRAPEZOID

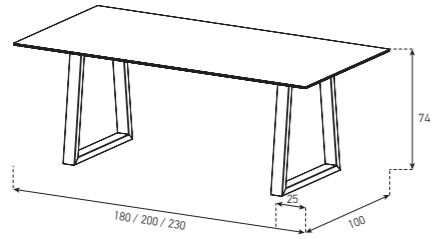

WARP

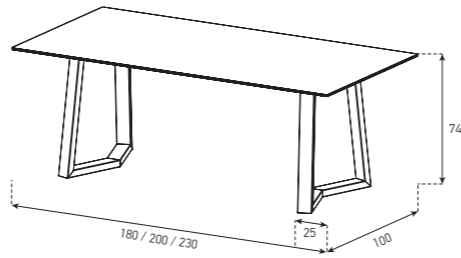

PORTAL

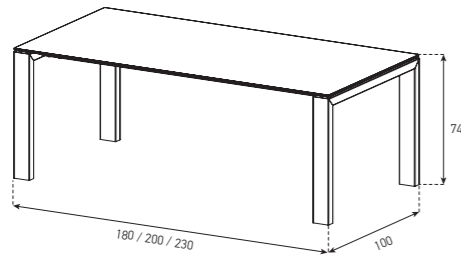

CHEVRON

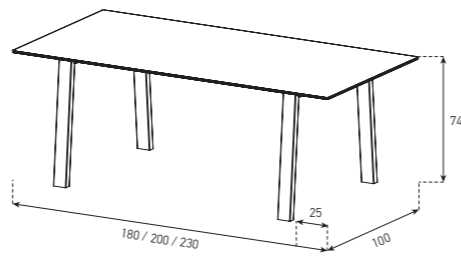

MIRROR

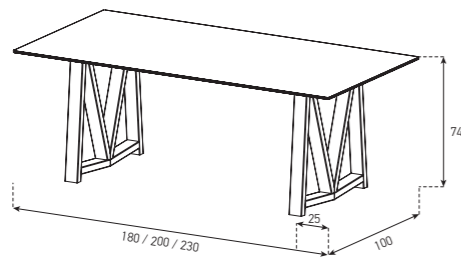

MAZE

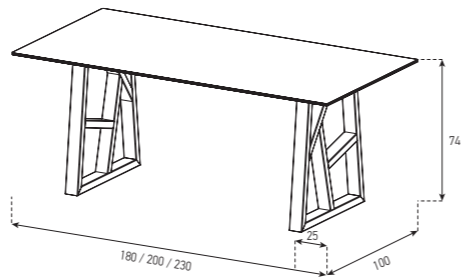

TWIN

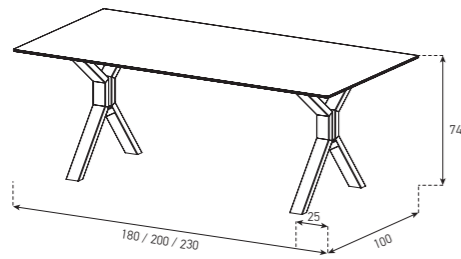

GONDOLA

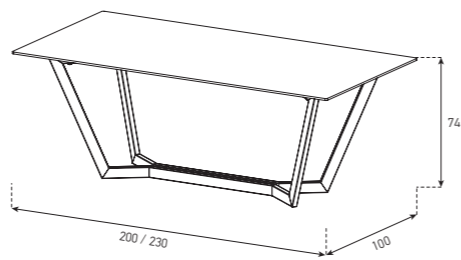

CONE

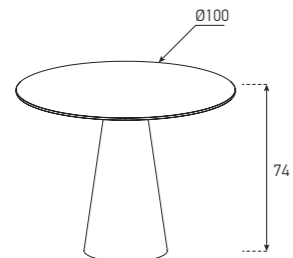

NET

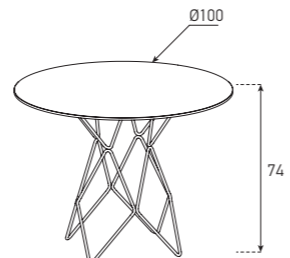

Table
CODE SAMPLE

TBL-F-R20EMP-MZ-BLK

1 2 3 4 5 6

1) Feature :

F
(Fixed)

L*
(Lift opening mechanism)

U*
(Universal opening mechanism)

2) Shape :

R
(Rectangle)

E
(Elliptical)

S
(Square)

C
(Circular)

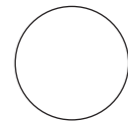
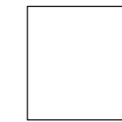
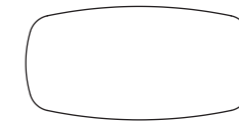

3) Dimensions (cm):

10
(100X100)

16
(160X100)

18
(180X100)

20
(200X100)

23
(230X100)

4) Table Decor : Category (F / F+)

5) Leg :

TR
(Trapezoid)

WR
(Warp)

TW
(Twin)

MZ
(Maze)

CH
(Chevron)

PT
(Portal)

MR
(Mirror)

GD
(Gondola)

CN
(Cone)

NT
(Net)

6) Leg Colors : Metal legs "Category (D)"
Solid wood leg only for PORTAL "Category (C)"

UNIVERSAL
OPENING

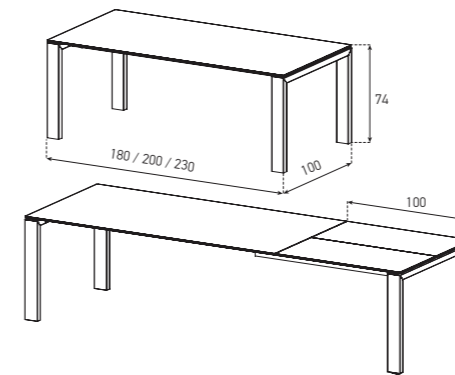

LIFT
OPENING

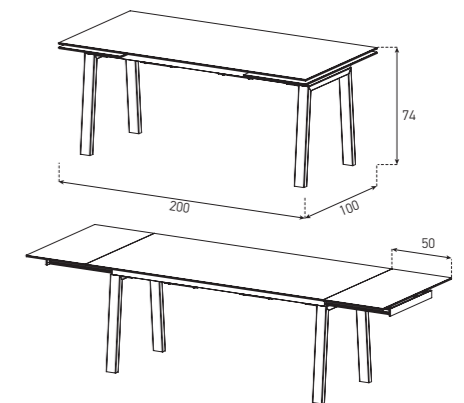

*Limitations:

- 1) Feature: Lift opening mechanism works only with "CHEVRON" leg. Universal opening mechanism works only with "PORTAL" leg.
- 2) Shape: Only "RECTANGLE" shape have opening mechanism
- 3) Dimensions: "16" is available for only "LIFT" feature
- 5) Legs: "CN" and "NT" only for "S" and "C" shaped tables

**SHELF & BOX SYSTEM
CODE SAMPLE**

**SHELF & BOX SYSTEM
SAMPLE ORDER CODES**

Standart column measures (cm)

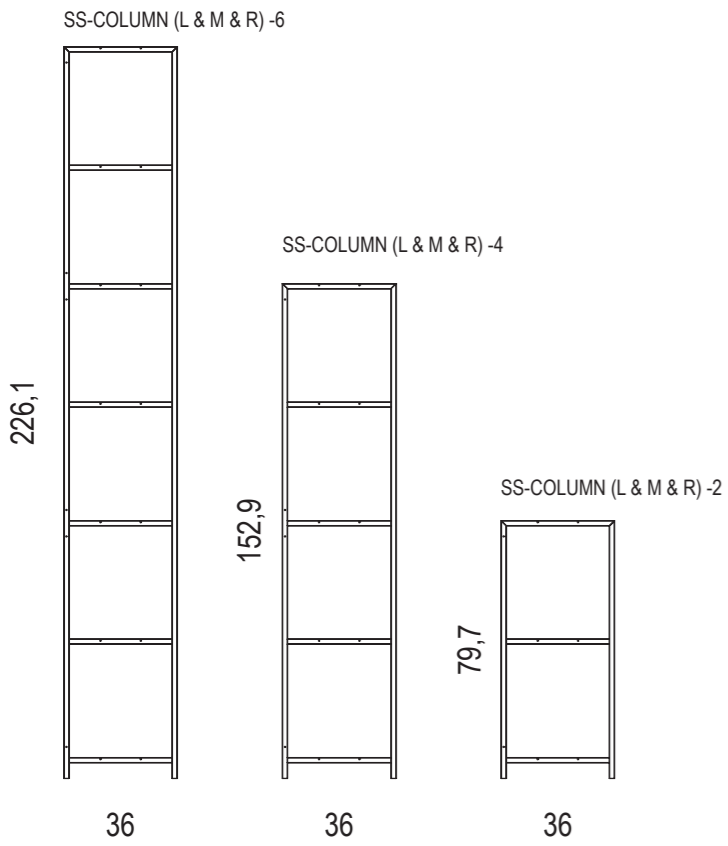

Note: L & M & R = Left & Middle & Right

Shelf

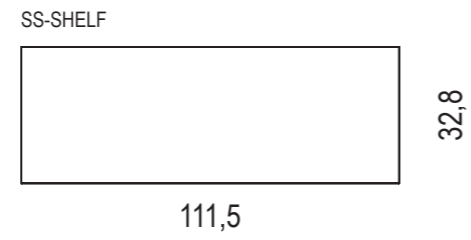

Storage box

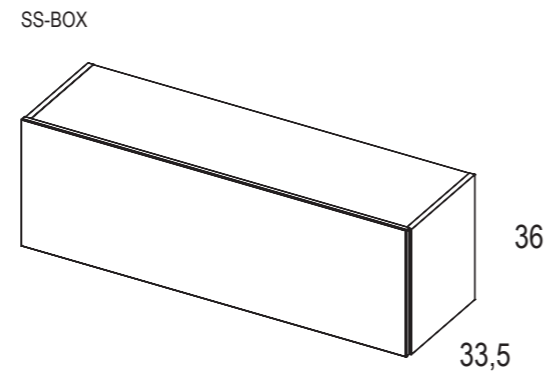

Equalizer

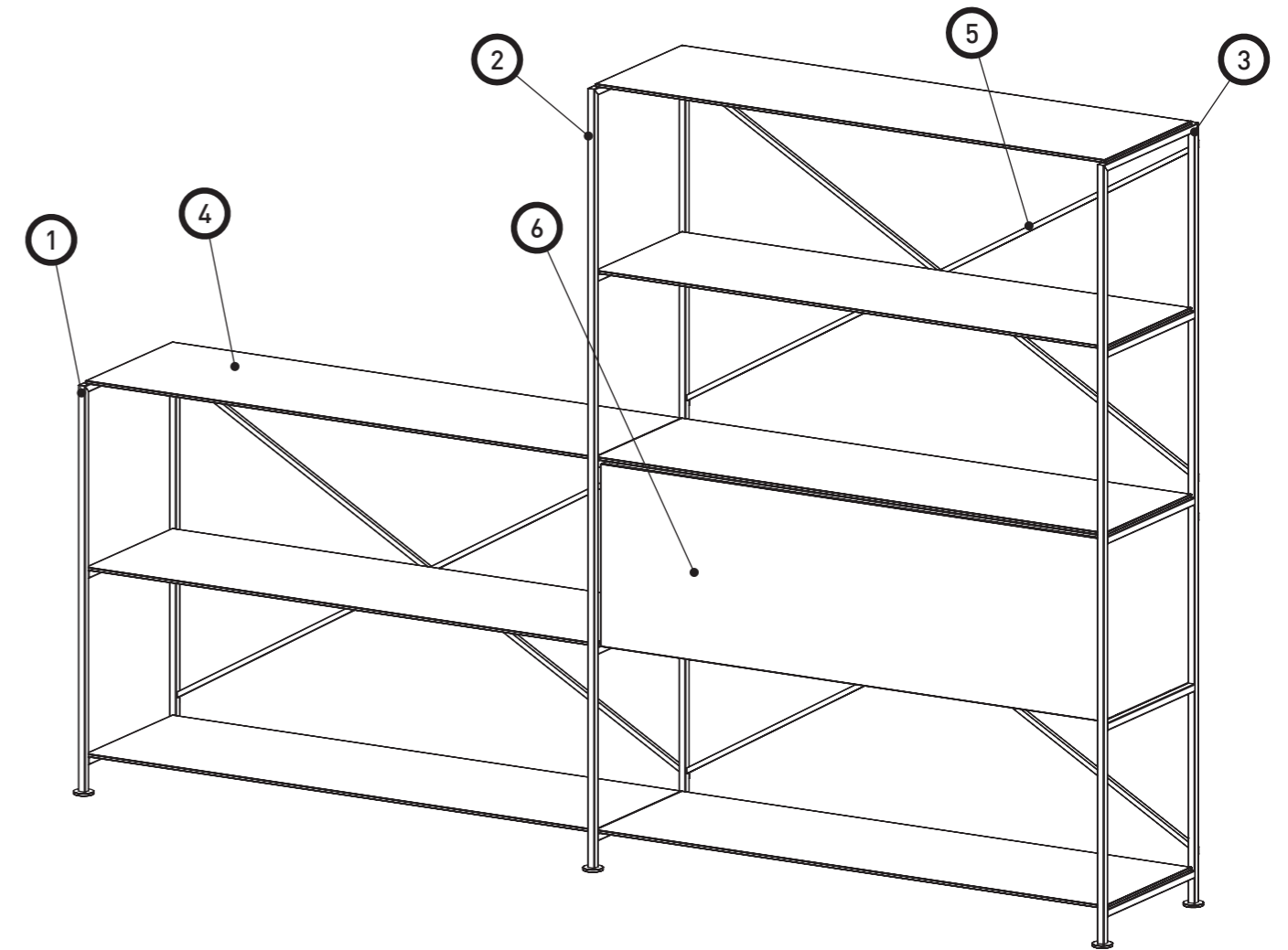
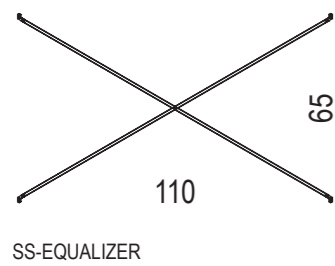

COLUMNS:

- 1. SS-COLUMN LEFT-2-WHT X1
- 2. SS-COLUMN MIDDLE-4-WHT X1
- 3. SS-COLUMN RIGHT-4-WHT X1

SHELVES:

- 4. SS-SHELF-WHT -WHTC X7

EQUALIZERS:

- 5. SS-EQUALIZER-WHT X3

STORAGE BOX:

- 6. SS-BOX-WHT-PLS X1

Headquarter

**Merkez Mah. Selimiye Cad. No: 1
Güzle İş Mrk. Kat:4 Çekmeköy 34782 İstanbul/Turkey
T.+90.216.640 16 16 F.+90.216.640 02 55**

Factory

**A.O.S.B. Kayalıođlu Mah. 3. Cad. No:26
Akhisar / Manisa / Turkey
T.+90.236.427 27 70 F.+90.236.427.27.72**

